

KISSsoft 03/2017 – Tutorial 7

Roller bearings

KISSsoft AG

Rosengartenstrasse 4
8608 Bubikon
Switzerland

Tel: +41 55 254 20 50
Fax: +41 55 254 20 51
info@KISSsoft.AG
www.KISSsoft.AG

Contents

1	Task	3
1.1	General.....	3
1.2	Task.....	3
1.3	Modeling the system.....	4
1.4	Adding Bearings	5
1.5	Roller bearing calculation	7
1.6	Settings.....	8
2	Further Calculations	11
2.1	Calculation with load spectra.....	11
2.2	Calculating the thermally permissible service speed limit	13
2.3	Extending the Roller Bearings Database.....	15
2.4	Calculating a single bearing with known loads.....	15

1 Task

1.1 General

In KISSsoft, roller bearings are usually analyzed as part of the shaft analysis process. The calculation of journal bearings (which are also available in KISSsoft) is not discussed here. In this tutorial, roller bearings are not viewed separately from their environment. Instead, they are treated as part of a system that consists of a shaft, external loads and bearings. The great advantage of this approach is that the calculation of loads on the roller bearing is performed automatically and therefore is less prone to user errors. The same applies to statically over-determined systems. You can also analyze individual bearings that are subject to a known load. For more information about this, see section 2.4.

1.2 Task

In this example, the multiple bearings shown in Figure 1 are to be analyzed. The system is statically over-determined: the first bearing is positioned within the shaft and the third bearing is an axial bearing supported on its right-hand side. The other bearings are not subjected to the axial forces.

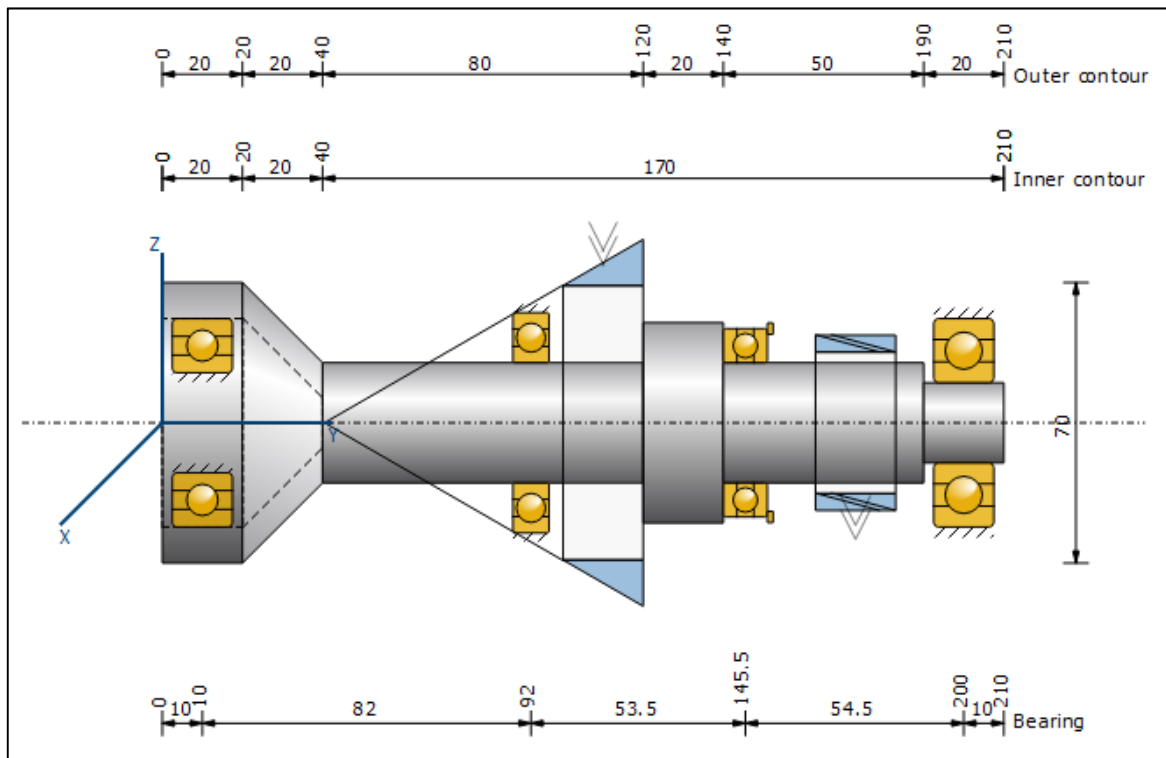

Figure 1. Support example for this tutorial

Position y [mm]	Type	Type	Type of bearing	Dimensions
10	Koyo 6205	Deep groove ball bearing (single row)	Non-locating bearing	d = 25 mm D = 52 mm
92	Koyo 16006	Deep groove ball bearing (single row)	Non-locating bearing	d = 30 mm D = 55 mm
145	Koyo 51106	Axial groove ball bearing (single row)	Axial bearing, adjusted on right side	d = 30 mm D = 47 mm
200	Koyo 6304	Deep groove ball bearing (single row)	Non-locating bearing	d = 20mm D = 52mm

Figure 2. Bearing types and positions

1.3 Modeling the system

First of all, model the shaft geometry as shown in Figure 1 (see also Tutorial 006: Shaft editor). In a second step, define the two force elements (bevel gear and cylindrical gear) with the data shown in Figure 3.

Position [mm]	Type	Angle		Pitch diameter [mm]	Width [mm]	Power [kW]	Direction
		Meshing [°]	Helix [°]				
110	Bevel gear	20	0	80	20	30	driven
173	Cylindrical gear	20	15	40	20	30	driving

Figure 3. Loads

The reference cone angle of the bevel gear is $\delta = 30^\circ$.

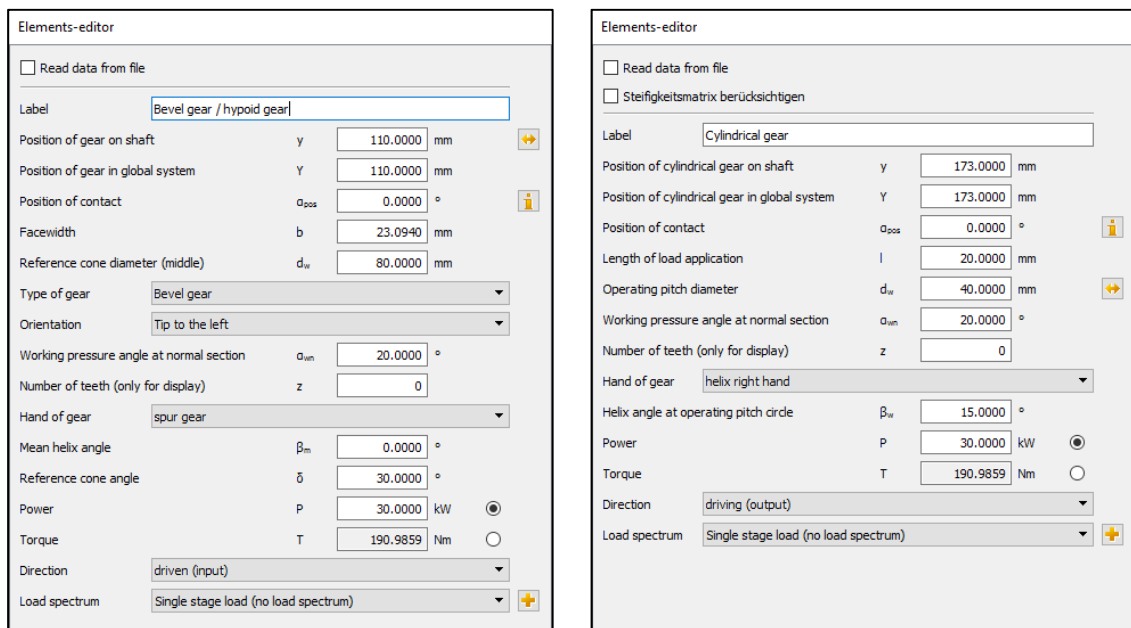
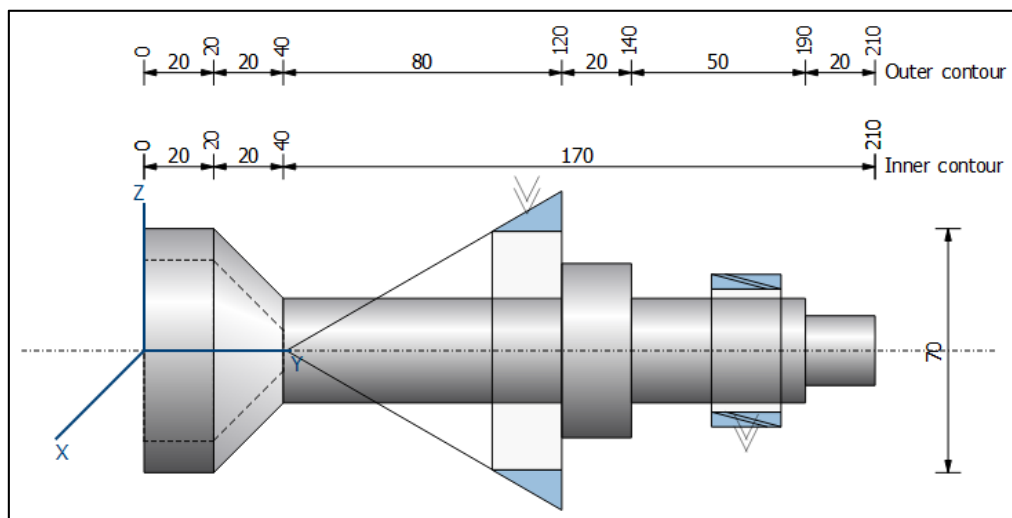

Figure 4. Definition of the force elements

After this, the following system should be visible in the graphical shaft editor:



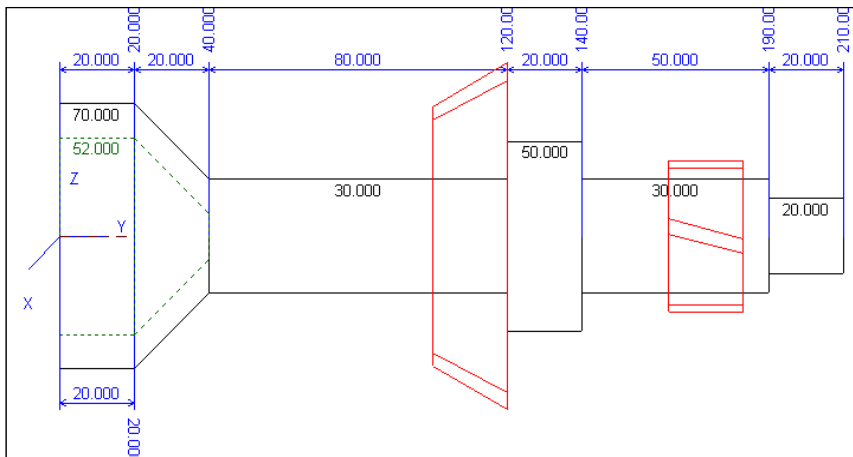

Figure 5. Geometry of the shaft and force elements

1.4 Adding Bearings

In the "**Elements-tree**", right-hand mouse click on "Bearing" and then select the "**Roller bearing**" option from the context menu:

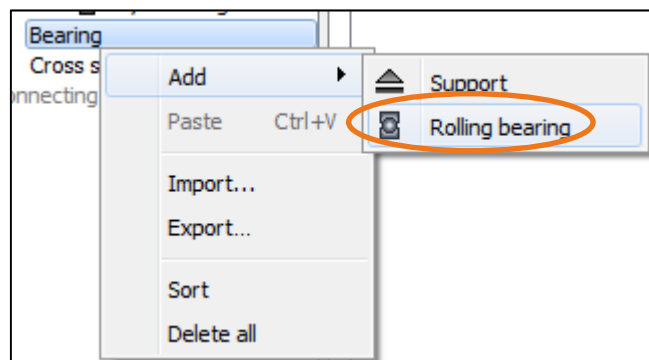

Figure 6. "Elements-tree" with the context menu for the "Bearing" group

As shown in Figure 7, the "**Elements-editor**" lists the most important bearing parameters.

To position the bearing at $y = 10$ mm within the shaft, click the radio button to the right of the "**External diameter**" input field. From the drop-down list with the same name, select the entry 52.00 mm and select "**Type Koyo 6205 (d = 25 mm, D = 52 mm, B = 15 mm)**" from the drop-down list for the label. Then click the sizing button to the right of the drop-down lists for the inner diameter or outer diameter to modify the relevant diameter to the shaft's geometry at the specified position.

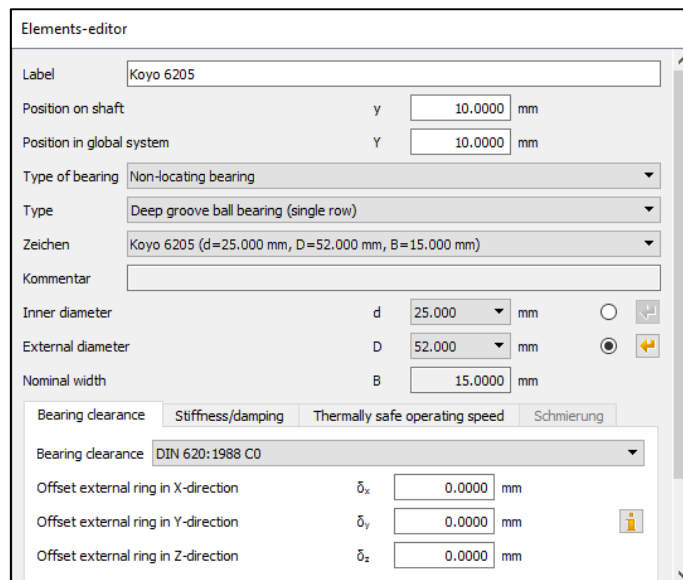
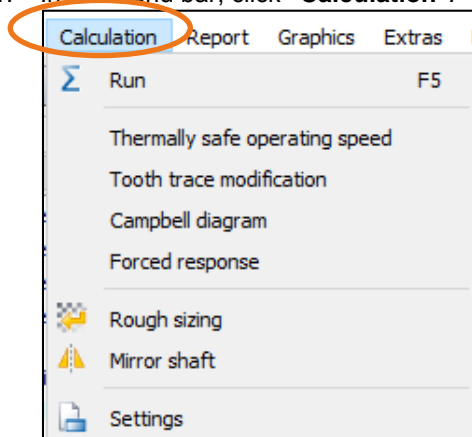

Figure 7. "Elements-editor" with roller bearing parameters

If this bearing is not present in the list, check that bearings produced by Koyo have been included in the list of available bearings. To do this:

1. In the menu bar, click **"Calculation"**.



2. There, select **"Settings"**. This opens the **"Module specific settings"** window.
3. In the "Bearing manufacturers" group you can now select the companies you want to include in the list of available bearing manufacturers. If necessary, enable "Koyo" by clicking the checkbox of the same name.

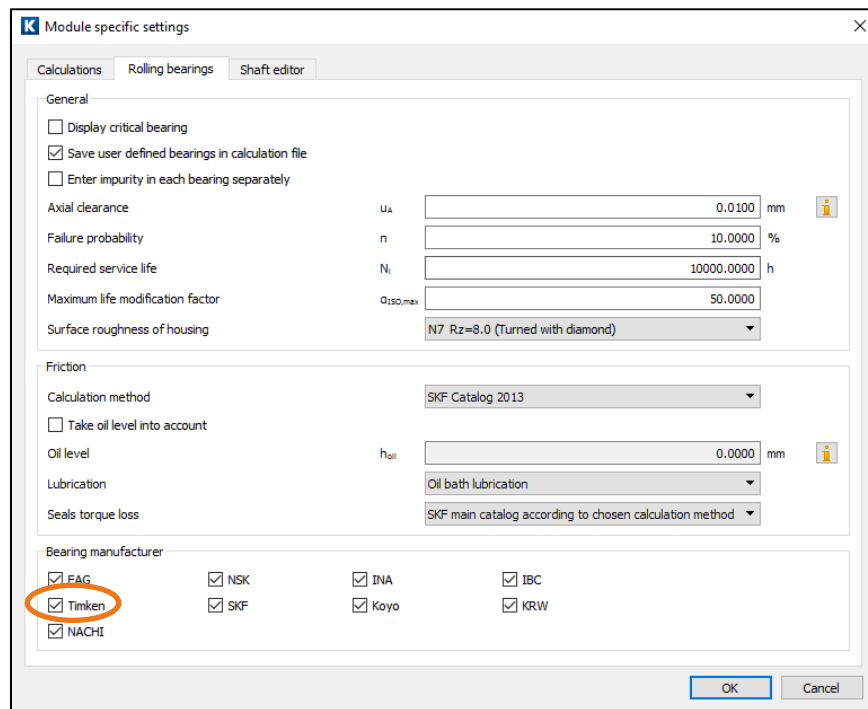

4. Click OK to close the window.

The system comprising shaft, loads and bearings should now look like the one shown in Figure 1.

1.5 Roller bearing calculation

Start the shaft calculation by clicking on  in the toolbar or else press F5 to run the roller bearing calculation. You can see a quick overview of the results in the "Results" window (see Figure 8). Please note that you must enter the bearing names manually.

The image shows a "Results" window with a summary overview of the roller bearing analysis. The results are as follows:

Results					
maximum deflection	21.84 μm				
maximum equivalent stress	103.05 N/mm ²				
minimum bearing service life	254.36 h				
minimum static bearing safety	1.12				
Bearing service life	S0 Ln_h				
Koyo 6205	15.67 473891 h				
Koyo 16006	3.93 4748 h				
Koyo 51106	12.33 4593 h				
Koyo 6304	1.12 254 h				
Bearing reaction force	Component X Y Z Rxz				
Koyo 6205	F	-193.258 N	0.000 N	462.092 N	500.877 N
	M	0.000 Nm	0.000 Nm	-0.000 Nm	0.000 Nm
Koyo 16006	F	1.696 kN	0.000 kN	0.792 kN	1.872 kN
	M	0.000 Nm	0.000 Nm	0.000 Nm	0.000 Nm
Koyo 51106	F	-0.000 kN	-3.423 kN	0.000 kN	0.000 kN
	M	0.000 Nm	0.000 Nm	0.000 Nm	0.000 Nm
Koyo 6304	F	3.598 kN	0.000 kN	-6.015 kN	7.008 kN
	M	0.000 Nm	0.000 Nm	0.000 Nm	0.000 Nm

Figure 8. "Results" window with a summary overview of the roller bearing analysis

In the "bearing service life" list you will now see the following values for each bearing:

- S0 Static safety
- Lnh Rating life in [h]
- Lnmh Modified rating life in [h]¹
- Lnrh Basic reference rating life according to ISO/TS 16281 in [h]²
- Lnmrh Modified reference rating life according to ISO/TS 16281 in [h]^{1,2}

The bearing reaction force list shows the reaction forces and moments for each component (see Figure 9). Here the F_y component refers to the axial force, and the M_y component refers to the torque.

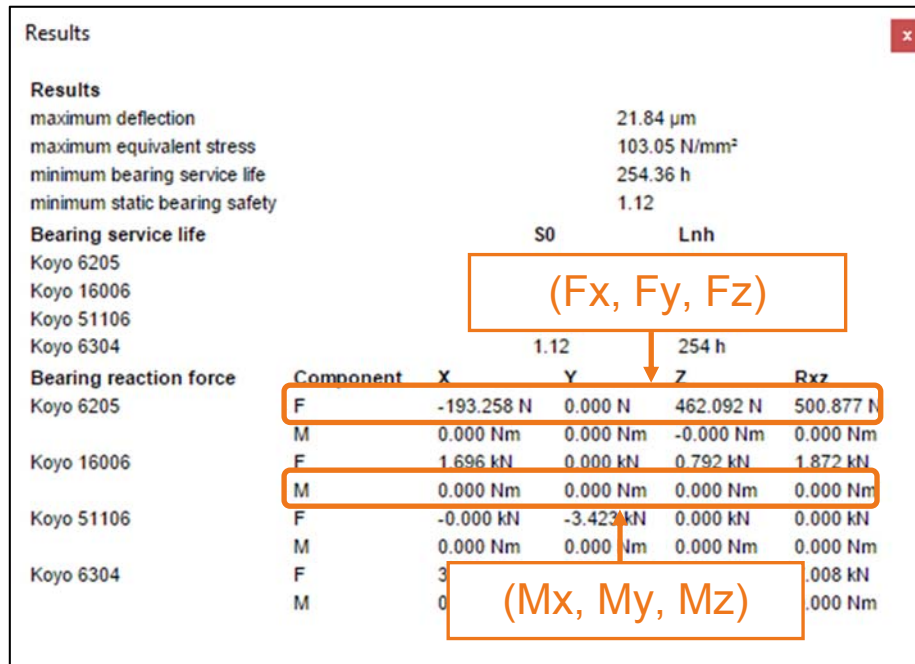

Figure 9. Components of bearing reaction forces and moments

1.6 Settings

Some settings have a direct effect on roller bearing analysis. These parameters are listed below.

¹ If you select "Enhanced bearing service life according to ISO 281" in the "Basic data" tab

² If you select "Roller bearing service life according to ISO/TS 16281" in the drop-down list for "Roller bearing" in the "Basic data" tab.

Figure 10. "General" group in the "Basic data" tab with values that have a direct effect on roller bearing analysis

Speed: the higher the speed, the shorter the rating life in [h].

Sense of rotation: possibly changes the sign of axial load, for example, this happens when helical gears are used. This changes the effect of load on the bearing.

Lubricant temperature: a higher lubricant temperature reduces the service life coefficient.

Roller bearing: in the roller bearing drop-down list you can select one of the four following options:

- ["Rolling bearing service life, classical calculation \(ISO 281 and manufacturer data\)"](#)
Roller bearings primarily place constraints on the degree of freedom of movement in displacement and/or rotation, which is why they are modelled in this way when you select this option. You can enter any value as the stiffnesses for translation and rotation, no matter what type or size of bearing is involved. The correlation between axial and radial forces, such as experienced by tapered roller bearings, is included in the calculation.
- ["Roller bearing stiffness calculated from inner geometry; Rolling bearing service life, classical calculation"](#)
This takes into account internal roller bearing data, such as roller diameter, race radius to determine bearing stiffness. If no detailed data is available, it will be estimated on the basis of the size and type of bearing.
- ["Rolling bearing service life from inner geometry \(ISO/TS 16281\)"](#)
Service life calculation taking into account internal bearing geometry. The results are displayed in the "Results" window with L_{nrh} or L_{nmrh} .

"Modified rating life according to ISO 281"

If a flag is set in this checkbox, the influence of the lubricant is taken into consideration in the bearing rating life calculation. The results are displayed in the "**Results**" window with L_{nmh} or L_{nmrh} .

Figure 11. "Rolling bearings" group in the "Basic data" tab with lubricant parameters

Lubrication: the choice of the type of lubricant affects the service life coefficient.

Impurity: the impurity coefficient e_c affects the service life coefficient.

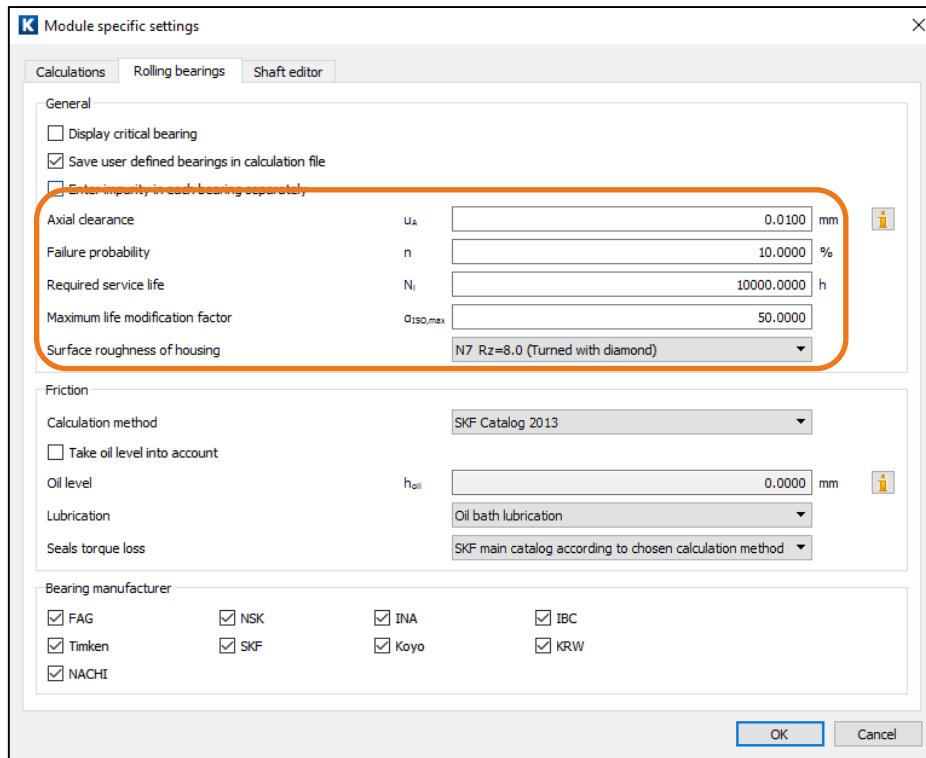

Figure 12. "Module specific settings" window in the "Roller bearing" tab with roller bearing parameters

Failure probability: a_1 is used in calculating the rating life of roller bearings. By default it is set to 10%, but can be altered here.

Required service life: this specifies the required service life in the roller bearing calculation. However, this value does not actually affect the roller bearing calculation. If the calculated service life drops below the required service life, the program issues a warning message.

Maximum service life coefficient: In this input field you define the upper limit for the service life coefficient a_{ISO} .

$$a_{ISO} = \begin{cases} a_{ISO} \Leftrightarrow a_{ISO} < a_{ISO,max} \\ a_{ISO,max} \Leftrightarrow a_{ISO} \geq a_{ISO,max} \end{cases}$$

The default value defined in ISO 281:2007-2 is $a_{ISO} = 50$.

2 Further Calculations

2.1 Calculation with load spectra

In the "**Basic data**" tab, in the **drop-down list** for load spectra, you can specify whether the load spectra defined when the shaft was modelled (e.g. cylindrical gear) are to be taken into account (see Figure 13).

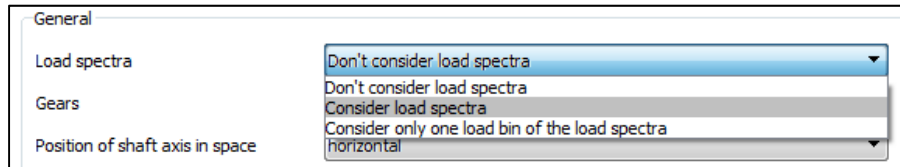

Figure 13. Drop-down list for load spectra in "Basic data"

To do this, select the "**Consider load spectra**" option.

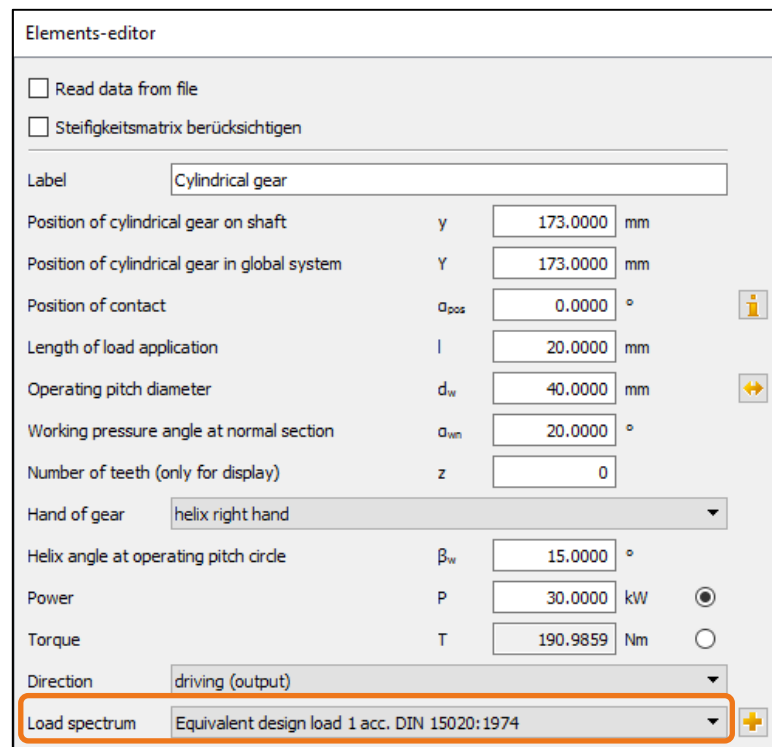



Figure 14. Example that takes a load spectrum into consideration for the force element cylindrical gear

To add your own load spectrum entry to the database, follow these steps:

1. Open the database tool via "**Extras**" → "**Database tool**".
2. At the prompt (for authorization to write data to the database), click Yes. This opens the database tool window.
3. Here, select the Load spectra table and click Edit. The database tool window now shows a list of the entries in the LASTKOLL (load spectra) table.
4. You now have two options for defining your own load spectrum: Either select a data record from the list and change it, or generate an entirely new data record. If you decide to use the first option, select an existing data record from the list and then click the  button.
5. If you want to create a completely new entry, click the  button without first selecting an existing entry.

6. In both cases, the **"Create a new entry"** dialog window appears. Here you can input the name of your choice for your load spectrum in the **"Label"** input field.
7. Here you can either enter the actual load spectrum directly, in the table in the lower part of the window, or input the name of the file to be used for the load spectrum in the **"File name"** input field. The file name must have the **dat** file extension, e.g. **own load spectra.dat** and be saved to the <KISSsoft installation folder>/DAT folder.
8. If a file with the same name is already present, click the **"Edit"** button to start an editor with which you can edit the file contents.

In each case you see the frequency, torque or power factor and speed factor in a line, separated by tab spaces. In Figure 15 you see the "meinLastKollektiv.dat" file as it appears in the Windows editor.

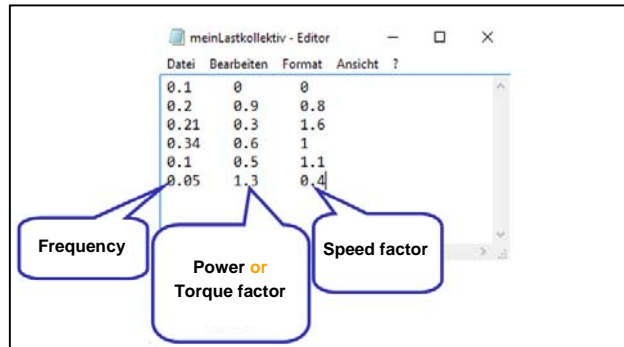

Figure 15. Example of a file with your own load spectrum data. The values are displayed in a line, each separated by a tab

The values in this file are multipliers of the reference values **"Power"** or **"Torque"** and **"Speed"**.

Example:

Let us suppose that you have entered the following reference values in the Basic data input window or in the Elements-editor for the cylindrical gear force element:

$$P = 115 \text{ kW}, n = 1500 \text{ 1/min}$$

In addition, you then decide to input multipliers for power and not for torque (see Figure 17).

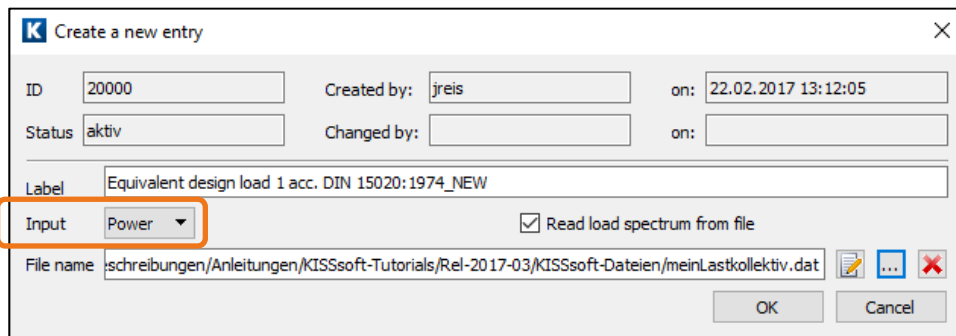

Figure 16. "Create a new entry" window with the efficiency factor (power) selected

In the Input drop-down list you can specify whether you want to multiply the power or the torque with the values of the load spectrum. For the load spectrum shown in Figure 15 you then receive the absolute values, as displayed in Figure 17:

Frequency [%]	Power [kW]	Speed [1/min]
10	0	0
20	103.5	1200
21	34.5	2400
34	69	1500
10	57.5	1650
5	149.5	600

Figure 17. Example of a load spectrum

2.2 Calculating the thermally permissible service speed limit

The method used to determine the thermally permissible service speed is described in DIN 732. This limit can differ greatly from other permitted service speeds because the reference conditions only apply to fully defined cases. In order to define the thermally permissible operating limit, you must first define the thermal nominal speed for each case. This is the bearing-specific speed of rotation reached under predefined operating conditions such that the heat development (friction) balances the heat dissipation (through bearing contact and lubrication). Mechanical or kinematic criteria are not taken into account for this speed. The reference values (temperatures, load, lubricant viscosity, reference surface of the bearing etc.) have been fixed so that the reference speeds with either oil or grease lubricated bearings will result in identical values.

Open the **"Thermally permissible service speed"** input window by clicking the **"Calculation→"Thermally permissible service speed"** menu.

The screenshot displays the software interface for calculating the thermally permissible service speed. The main window has tabs for 'Shaft editor', 'Basic data', 'Strength', and 'Thermally safe operating speed'. The 'Thermally safe operating speed' tab is active, showing a dropdown for 'Lubrication type' set to 'Oil bath lubrication - oil level to middle of lowest rolling body'. To the right, there are input fields for 'Temperature around the bearing T_b ' (20.0000 °C) and 'Mean bearing temperature T_m ' (70.0000 °C). Below this is an 'Elements-editor' window with several tabs: 'Bearing clearance', 'Stiffness/damping', 'Thermally safe operating speed', and 'Schmierung'. The 'Thermally safe operating speed' tab is selected, showing the following parameters:

- Inner diameter d : 25.000 mm
- External diameter D : 52.000 mm
- Nominal width B : 15.000 mm
- Coefficient f_{0r} : 2.0000
- Coefficient f_1 : 0.0002
- Coefficient f_{2r} : 0.0002
- Heat-transferring reference surface A_s : 3628.5395 mm²
- Dynamic equivalent load P_1 : 500.8769 N
- Enter values:

Figure 18. Tab „Thermally permissible service speed“ in the shaft calculation

To open the "Thermally permissible service speed" window, first switch to the "Roller bearings ISO 281, ISO 76" calculation module. To do this, activate the **"Module tree window"** in the upper left-hand window by clicking on the corresponding **"Modules"** tab (see Figure 19).

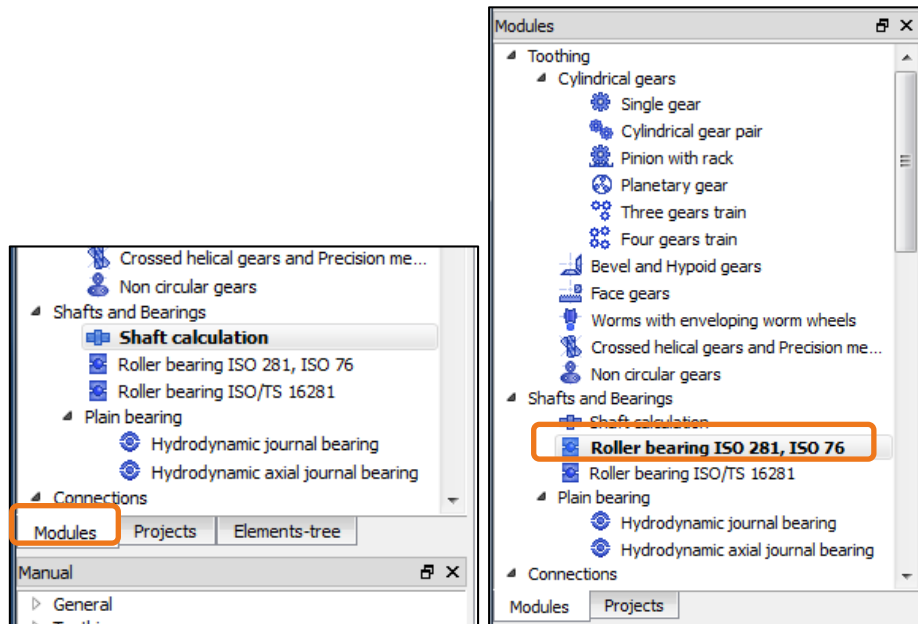

Figure 19. Opening "Roller bearing ISO 281, ISO 76"

In the module tree window, double-click on "Roller bearing ISO 281, ISO 76". You can now input parameters for the calculation in KISSsoft in the roller bearing calculation module in the "Thermally permissible service speed input" window. Open the "Thermally permissible service speed" input window by clicking the "Calculation→Thermally permissible service speed" menu (see Figure 20).

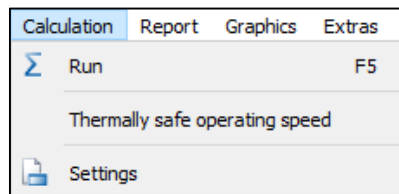



Figure 20. Activating the "Thermally permissible service speed" input screen

Basic data		Thermally safe operating speed			
General data					
Lubricant	Oil: ISO-VG 220				
Lubrication type	Oil bath lubrication - oil level to middle of lowest rolling body			Temperature around the bearing T_u	20.0000 °C
Mean bearing temperature	T_m	70.0000 °C		Lubricant operating temperature T_s	70.0000 °C
Bearing data					
		Bearing 1	Bearing 2	Bearing 3	Bearing 4
Coefficient	f_{0r}	0.000000	0.000000	0.000000	0.000000
Coefficient	f_1	0.000000	0.000000	0.000000	0.000000
Coefficient	f_{1r}	0.000000	0.000000	0.000000	0.000000
Heat-transfer...rence surface	A_s	0.0000	0.0000	0.0000	0.0000 mm ²
Dynamic equivalent load	P_1	0.0000	0.0000	0.0000	0.0000 N
Enter values		<input type="checkbox"/>	<input type="checkbox"/>	<input type="checkbox"/>	<input type="checkbox"/>

Figure 21. Active "Thermally permissible operating speed" tab

2.3 Extending the Roller Bearings Database

Data for several thousand roller bearings (from Koyo, NSK, SKF and Timken) are already stored in KISSsoft. You can also add any missing bearing data to this database. To add a new bearing to the database follow these steps:

1. Open the database tool via **"Extras" → "Database tool"**.
2. At the prompt (for authorization to write data to the database), click Yes. This opens the database tool window.
3. Here, from database W000, select the table of the corresponding roller bearing type, for example, description **"Deep groove ball bearing (single row)"**, table **"W05WNORM10"**. Then click **"Edit"**. The database tool window now shows a list of the entries in the **"W05WNORM10"** table.
4. You now have two options for defining your own roller bearing. Either select a data record from the list and change it, or generate an entirely new data record. If you decide to use the first option, select an existing data record from the list and then click the  button.
5. If you want to create a completely new entry, click the  button without first selecting an existing entry.
6. In both cases, the "Create a new entry" dialog window appears. You can now input any name for your roller bearing in the "Bearing label" input field. You can input parameters for the bearing in these two tabs: **"Basic data"** and **"Inner geometry"**. Although you must accept the values in "Basic data", you can input any values for inner geometry. If no inner geometry data is available, it is approximated based on the data entered in "Basic data".
7. Then click OK to confirm your entries. In the database tool window, then click "Save" to save your new entry. Note that no message appears to tell you that you have saved the file successfully. The roller bearing you have just added appears at the end of the list and has a sequential number ≥ 20000 .

2.4 Calculating a single bearing with known loads

If you want to analyze a single bearing with a known load, you do not need to model an entire system that includes a shaft, loads and bearings. Instead, simply click on the **"Basic data"** tab to open a window with the same name.

Basic data Thermally safe operating speed

Operating data

Speed n 1/min Number of bearings n_b

Axial force F_a N Required service life N_L h

Bearing data

	Bearing 1	Bearing 2
Type	<input type="text" value="Deep groove ball bearing (single row)"/>	<input type="text" value="Deep groove ball bearing (single row)"/>
Diameter	<input checked="" type="radio"/> inside <input type="radio"/> outside <input type="text" value="0.600"/> mm	<input checked="" type="radio"/> inside <input type="radio"/> outside <input type="text" value="0.600"/> mm
Label	<input type="text" value="SKF W 618/0.6 (d=0.600 mm, D=2.500 mm, B=1.000 mm)"/>	<input type="text" value="SKF W 618/0.6 (d=0.600 mm, D=2.500 mm, B=1.000 mm)"/>
Kommentar	<input type="text"/>	<input type="text"/>
Type of bearing	<input type="text" value="Non-locating bearing"/>	<input type="text" value="Non-locating bearing"/>
Radial force	<input type="text" value="0.0000"/> N	<input type="text" value="0.0000"/> N
Axial force	<input type="text"/>	<input type="text"/>

Additional data

Modified rating life Bearing clearance

Consider load spectra Taper roller/Angular contact

Figure 22. Active "Basic data" tab in roller bearing calculation

Radial loads are defined for each bearing in the "Bearing data" group and axial force is predefined globally in the "Operating data" group. The distribution of axial force on the individual roller bearing depends on which type of axial support is selected for each bearing. To perform the calculation then either click  or press "F5".