

# KISSsoft 03/2017 – Tutorial 2

## Cylindrical interference fit

**KISSsoft AG**

Rosengartenstrasse 4  
8608 Bubikon  
Switzerland

Tel: +41 55 254 20 50  
Fax: +41 55 254 20 51  
info@KISSsoft.AG  
www.KISSsoft.AG

# Contents

1	Starting KISSsoft.....	3
1.1	Selecting a calculation.....	3
2	Calculating a cylindrical interference fit.....	4
2.1	Task.....	4
2.2	Sizing a tolerance pair.....	5
2.3	Running the analysis and report.....	5
2.4	Further analysis options and settings.....	8
2.4.1	Settings.....	8
2.4.2	Calculate the maximum permissible nominal torque.....	9
2.4.3	Hub with varying outer diameters.....	10
2.4.4	Defining your own tolerances.....	10
2.4.5	Influence of temperature.....	11
2.4.6	Additional loads.....	12

# 1 Starting KISSsoft

You can call KISSsoft as soon as the software has been installed and activated. Usually you start the program by clicking "Start→Program Files→KISSsoft 03-2017→KISSsoft 03-2017". This opens the following KISSsoft user interface:

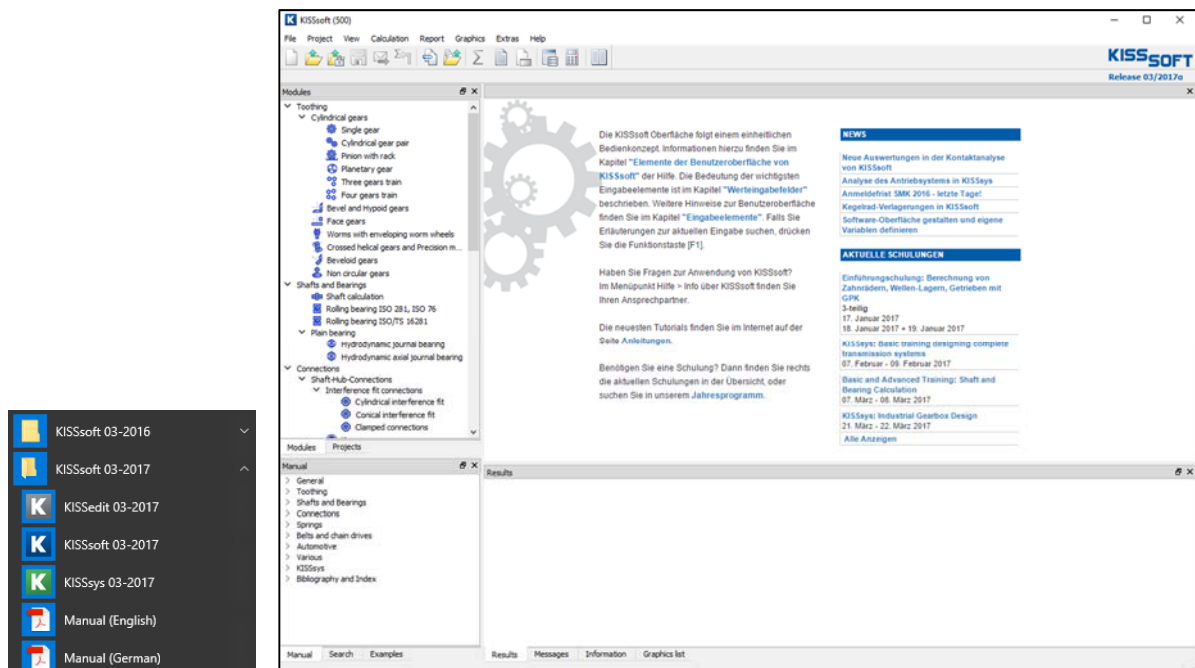

Figure 1. Starting KISSsoft, initial window

## 1.1 Selecting a calculation

In the modules tree window, select the "**Modules**" tab to call the calculation for the cylindrical interference fit:

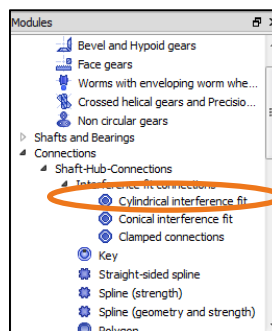

Figure 2. Selecting the "Cylindrical interference fit" calculation module under Shaft-Hub-Connections

## 2 Calculating a cylindrical interference fit

### 2.1 Task

To size a cylindrical interference fit, use the following data to ensure no sliding occurs.

Diameter of joint	$D_f$	60 mm	Coefficient of friction	$\mu_z$	0.12
Length of Interference fit	$l$	50 mm	Service temperature	$\Theta$	20°C
Outer diameter, Hub	$D_a$	90 mm	Application factor	$K_A$	1.25
Shaft bore	$D_i$	10 mm	Material shaft		34CrNiMo6
Nominal torque	$T$	400 Nm	Material Hub		C60
Axial force	$F_a$	200 N	Shaft surface quality	$R_z=4.8 \mu\text{m}$	N6
Speed	$n$	10'000 1/min	Hub surface quality	$R_z=4.8 \mu\text{m}$	N6

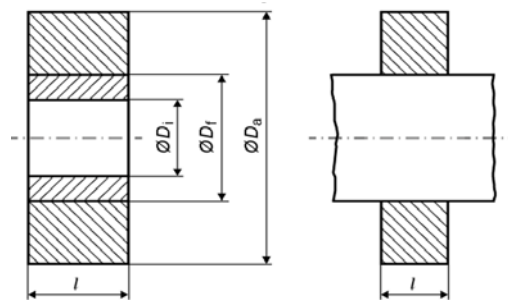

Enter this data as follows:

Figure 3. Input window - inputting the known data

The first step is to define a suitable tolerance pair.

## 2.2 Sizing a tolerance pair

Click  to the right of the entries for manufacturing tolerances, see the marking in Figure 3, to open a list with possible tolerance pairs. You can select any of these tolerance pairs, for example, the one that is most cost-effective to manufacture. Then click "OK" to transfer your selection to the main screen.

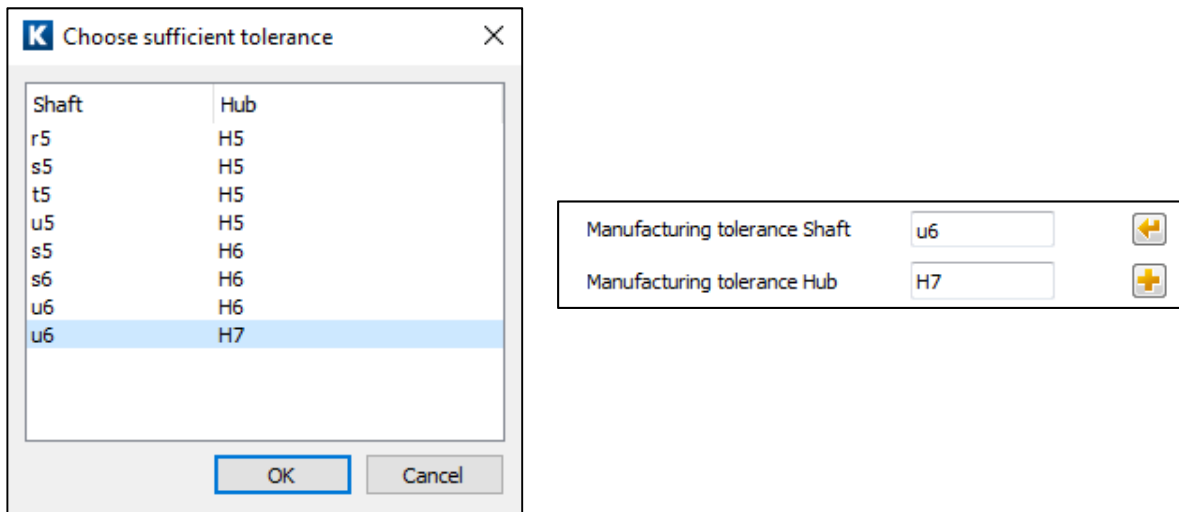



Figure 4. Selecting and transferring a tolerance pair

Alternatively, if you already know the tolerances of the shaft and hub, you can also input these values directly. This is described in section 2.4.4 "Defining your own tolerances". Now you have all the data required to verify an interference fit.

## 2.3 Running the analysis and report

Click the  icon in the tool bar (see Figure 6) or press "F5" to run the calculation. Some of the selected results then appear in the lower part of the main window (here, for example, safety against sliding). In the example shown here, KISSsoft displays this message:

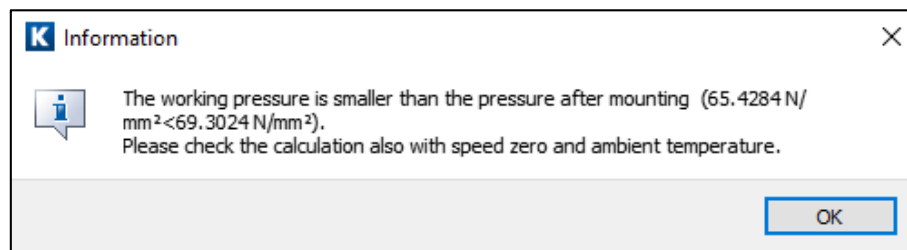



Figure 5. KISSsoft message

The forces created by operating speed mean that the pressure in the connection is higher during assembly than during operation. For this reason, you should run another calculation with speed set to zero to check the yield point during assembly. Click "OK" to close the message.

Note the "CONSISTENT" display (see Figure 6). This shows that the data you input matches the displayed results (for example, if you now change the nominal torque, the status "INCONSISTENT" is displayed until you click again  to rerun the calculation).

The method used to calculate a cylindrical interference fit is applied as specified by DIN 7190, valid for the elastic range.

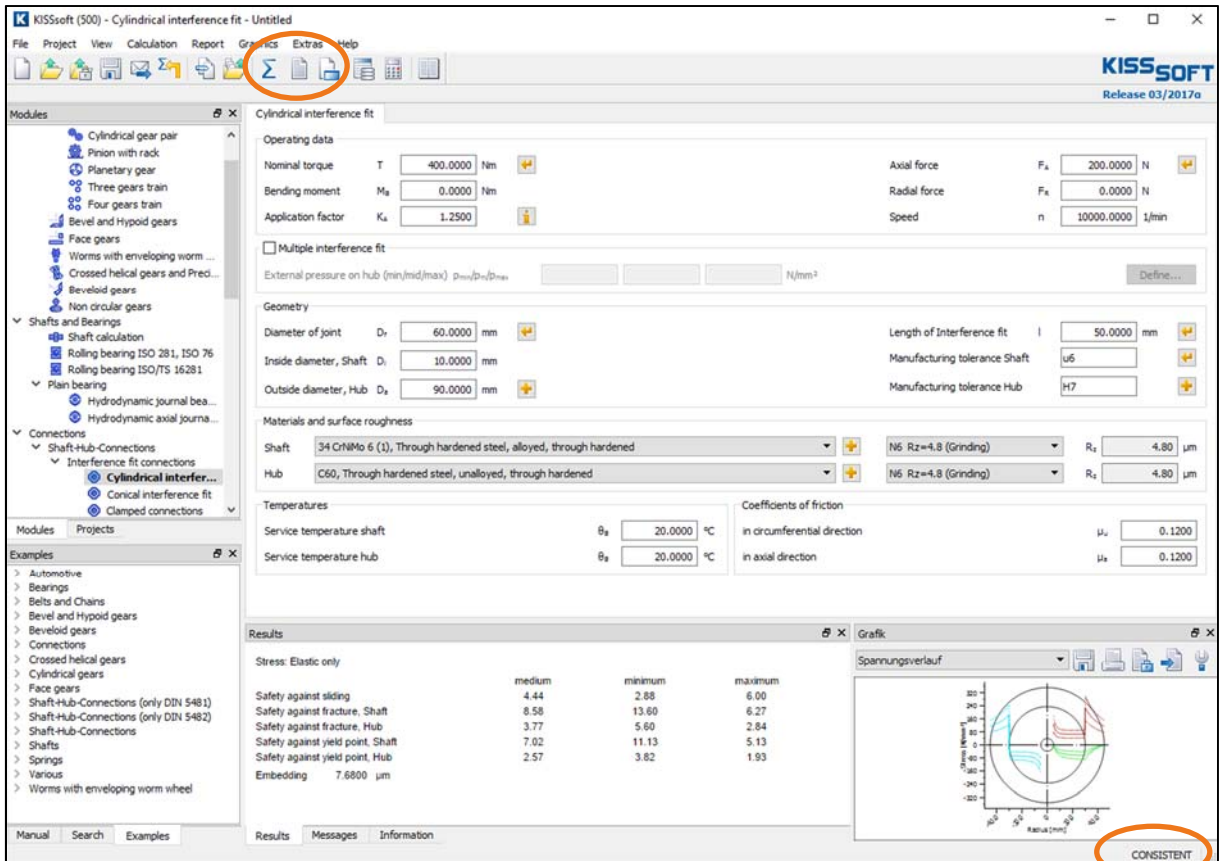



Figure 6. Performing the analysis - calling the report

Click the  icon in the tool bar (see Figure 6) or press "F6" to write the calculation report that lists all calculation parameters. You can now, for example, include this report in a proof report.

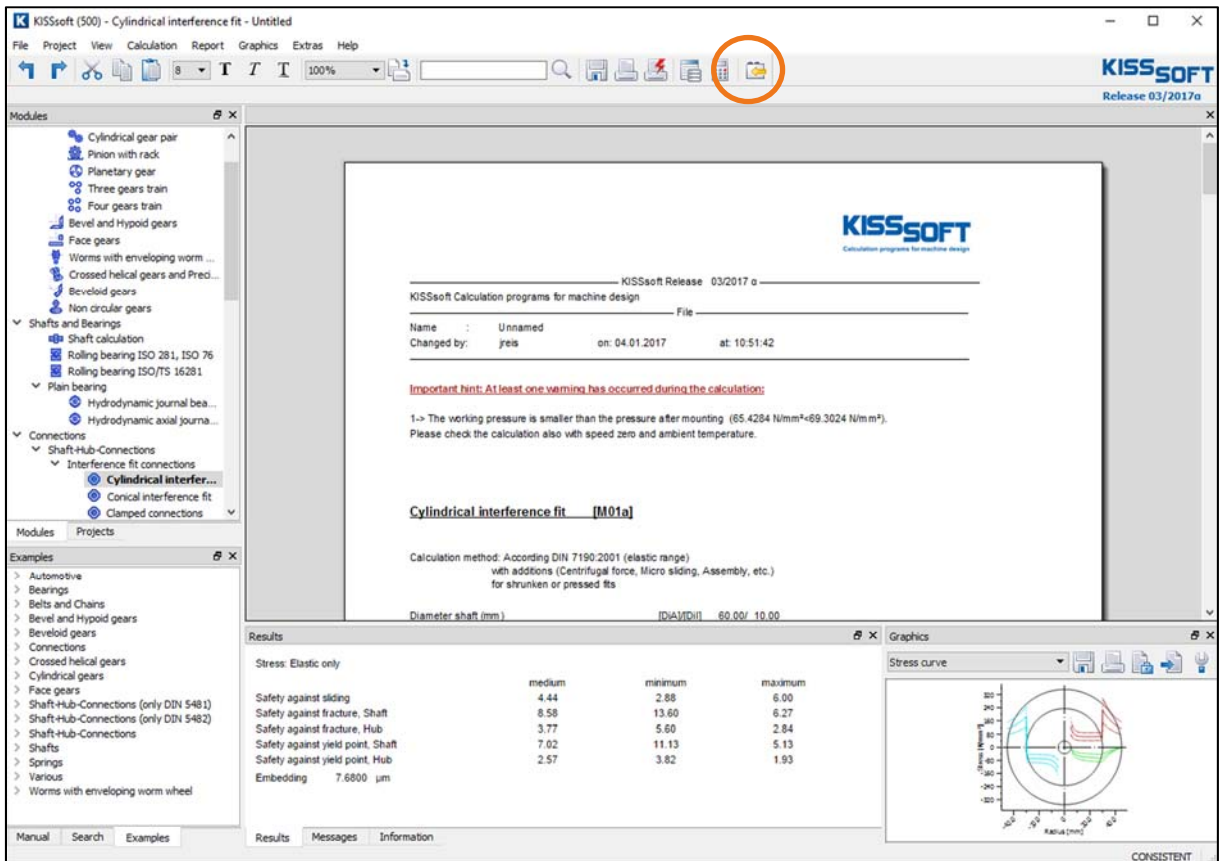

Figure 7. Report Viewer

The report also contains other results, for example "Details about hub and shaft temperature during assembly" or "Max. torque" to avoid micro sliding.

<u>Service / Mounting / Remounting</u>			
<b>Transverse-interference-fit:</b>			
Mounting clearance (mm)	[PsTh]		0.060
Temperature difference for mounting:			
Shaft temperature: (°C)	Hub temperature:	[ThA] (°C)	
20	261		
-150	135		
(calculated using coefficient of thermal expansion)			
Sub-cooling of the shaft according to DIN 7190	(10 <sup>-6</sup> /K)	[σw]	8.50
Coefficient of thermal expansion for hub	(10 <sup>-6</sup> /K)	[αn]	11.50
<b>Longitudinal pressure fit:</b>			
Assembly temperature shaft (°C)	[ThM]		20.00
Assembly temperature hub (°C)	[ThM]		20.00
Coefficient. of friction (longitudinal)	[μe=μa*1.300]		0.16
Press on (force) (kN)	[Fpress]		101.89 ( 68.08.. 135.71)
Coefficient. of friction (longitudinal)	[μl=μa* 1.600]		0.19
Press out (force) (kN)	[Fpress]		125.41 ( 83.79.. 167.03)
<b>Notice:</b>			
Micro sliding can occur in Interference fit!			
=> Risk of contact corrosion.			
Coefficient. of friction	[μ]		0.19
Max. torque to avoid Micro sliding (Nm)	[Tlimit]		561.60 ( 364.18.. 759.02)

Figure 8. Section of the report showing details about assembly and the limiting torque to prevent micro-sliding

Click the  icon, marked in Figure 7, to return to the input window.

## 2.4 Further analysis options and settings

### 2.4.1 Settings

Select the **"Calculation"→"Settings"** menu option, or use the tool bar, and click the appropriate button, to open this menu. The values shown here influence the calculation and must therefore be checked carefully.

**K** Module specific settings

Hypotheses of the equivalent stress according: Modification of shape thesis

Longitudinal interference fit

Assembly temperature shaft/hub (press on)  $\theta_M$  20.0000 20.0000 °C

Coefficient of friction (press on)  $\mu_e/\mu_s$  1.3000

Coefficient of friction (press off)  $\mu_{II}/\mu_s$  1.6000

Calculation of joining temperature (lateral interference fit)

Depends on joint diameter, per thousand of  $d_f$  (acc. DIN 7190) 1

Constant mounting clearance of 0.1000 mm

Temperature of shaft for joining 20.0000 °C

Required safety against sliding 1.2000

Required safety against yield point (shaft/hub) 1.0000 1.0000

Required safety against fracture (shaft/hub) 1.5000 1.5000

Required safety against permanent plastic strain (shaft/hub) 1.0000 1.0000

Calculate material strength with wall thickness as raw diameter

Allow calculation of elastic-plastic loaded interference fits

Calculate despite negative operating interference and report allowances

OK Cancel

Figure 9. Module specific settings

- Select the hypothesis for the equivalent stress.
- Required safety factors, especially against sliding. These values are not included in the calculation run. However, the system issues a warning if these values are not reached during the analysis process.
- Shows how the part strength is determined from test strength analysis (size influence).



## 2.4.2 Calculate the maximum permissible nominal torque

Now calculate the maximum permissible torque such that the minimum safety against sliding is 1.20. All other parameters remain as defined above.

To do this, click the "Sizing" button  to the right of the input field for nominal torque (see mark 1 in Figure 10). The software then determines the maximum nominal torque, which in this case is 959.68 Nm. If

you then recalculate the shaft hub connection with this load ( or press F5), the minimum safety against sliding will be equal to the required minimum safety of 1.2 (see mark 2 in Figure 10):

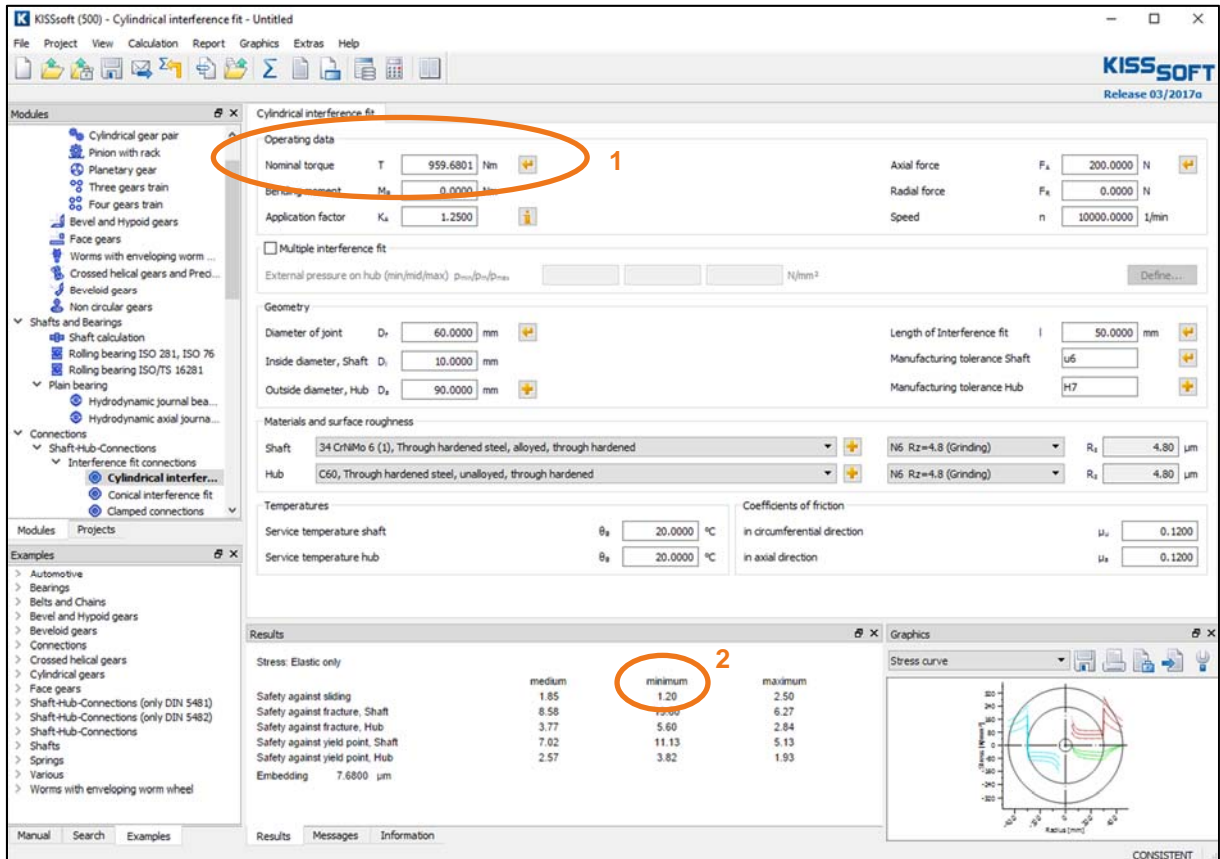



The screenshot displays the KISSsoft (500) - Cylindrical interference fit - Untitled window. The interface includes a menu bar, a toolbar, and a left-hand navigation pane. The main workspace is divided into several sections:

- Operating data:** Contains input fields for Nominal torque (959.6801 Nm), Bending moment (0.0000 Nm), Application factor (1.2500), Axial force (200.0000 N), Radial force (0.0000 N), and Speed (10000.0000 1/min). A "Sizing" button is circled in orange and labeled "1".
- Geometry:** Contains input fields for Diameter of joint (60.0000 mm), Inside diameter, Shaft (10.0000 mm), Outside diameter, Hub (90.0000 mm), Length of Interference fit (50.0000 mm), Manufacturing tolerance Shaft (u6), and Manufacturing tolerance Hub (H7).
- Materials and surface roughness:** Contains dropdown menus for Shaft (34 CrNiMo 6 (1), Through hardened steel, alloyed, through hardened) and Hub (C60, Through hardened steel, unalloyed, through hardened), along with surface roughness parameters (Rz=4.8 (Grinding) and Ra=4.80 μm).
- Temperatures:** Contains input fields for Service temperature shaft and hub (20.0000 °C).
- Coefficients of friction:** Contains input fields for μs in circumferential direction (0.1200) and μa in axial direction (0.1200).
- Results:** A table showing safety factors for various failure modes. The "Safety against sliding" row has a value of 1.20 circled in orange and labeled "2".
- Graphics:** A "Stress curve" graph showing stress distribution across the radius.

	medium	minimum	maximum
Safety against sliding	1.85	1.20	2.50
Safety against fracture, Shaft	8.58	12.00	6.27
Safety against fracture, Hub	3.77	5.60	2.84
Safety against yield point, Shaft	7.02	11.13	5.13
Safety against yield point, Hub	2.57	3.82	1.93
Embedding	7.6800 μm		

Figure 10. Sizing to maximum nominal torque

### 2.4.3 Hub with varying outer diameters

Click the "Plus" button  to the right of the input for the hub outside diameter to allow extended input for hub geometry. Click this "Plus" button  to define a hub with a variable outer diameter. This hub in this example has 90 mm outer diameter for 25 mm length and 100 mm outer diameter for 25 mm length:

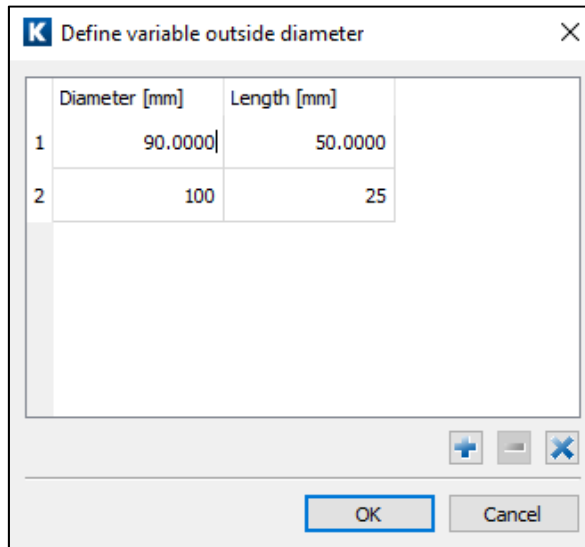

Figure 11. Defining a hub with variable outer diameter

However, you can only input this data if the shaft does not have a bore. Otherwise the following error message appears.

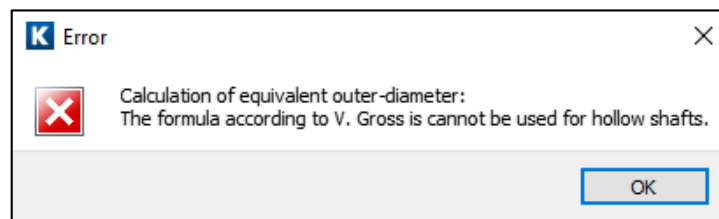



Figure 12. Error message

### 2.4.4 Defining your own tolerances

Click the "Plus" button  to the right of the input field for tolerances to input your own tolerance values. To do this, set the flag in the checkbox for "**Own tolerances**" and input the value you require:

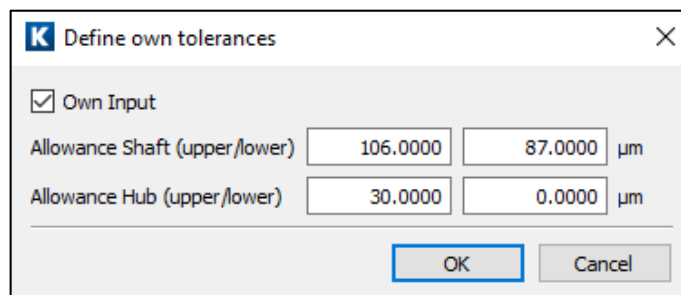

Figure 13. Defining your own tolerances

## 2.4.5 Influence of temperature

The reference temperature is 20°C.

**Note:** the maximum operating temperature is 700°C.

However, if you input a different operating temperature in the main screen, the interference pressure changes as a function of the difference in the coefficient of thermal expansion of the shaft/hub material. You can modify this by setting the material to **"Own Input"** in the material properties screen.

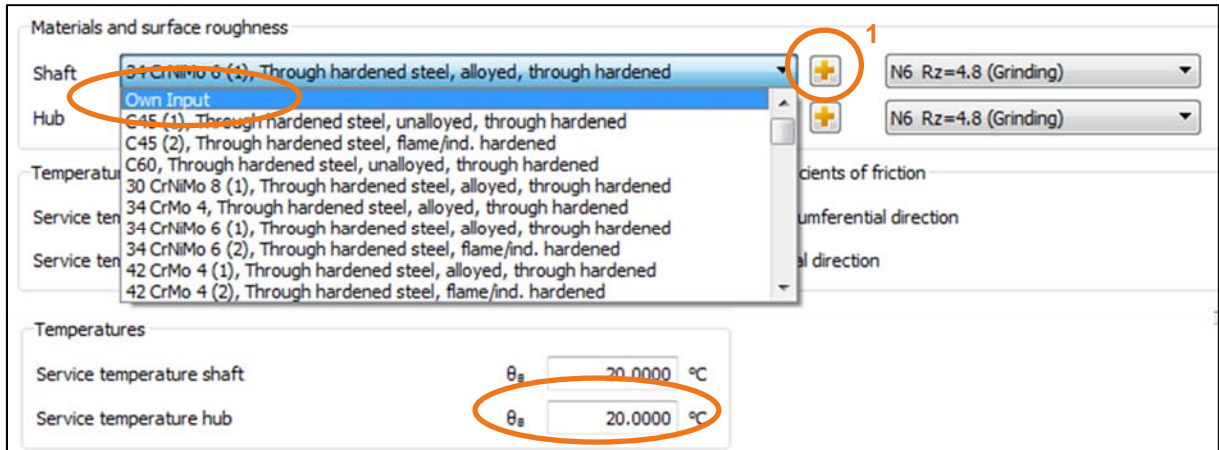



Figure 14. Inputting your own material (in particular coefficient of thermal expansion) and operating temperature

Click  (mark 1 in Figure 14) to the right of the material selection list to modify the material properties:

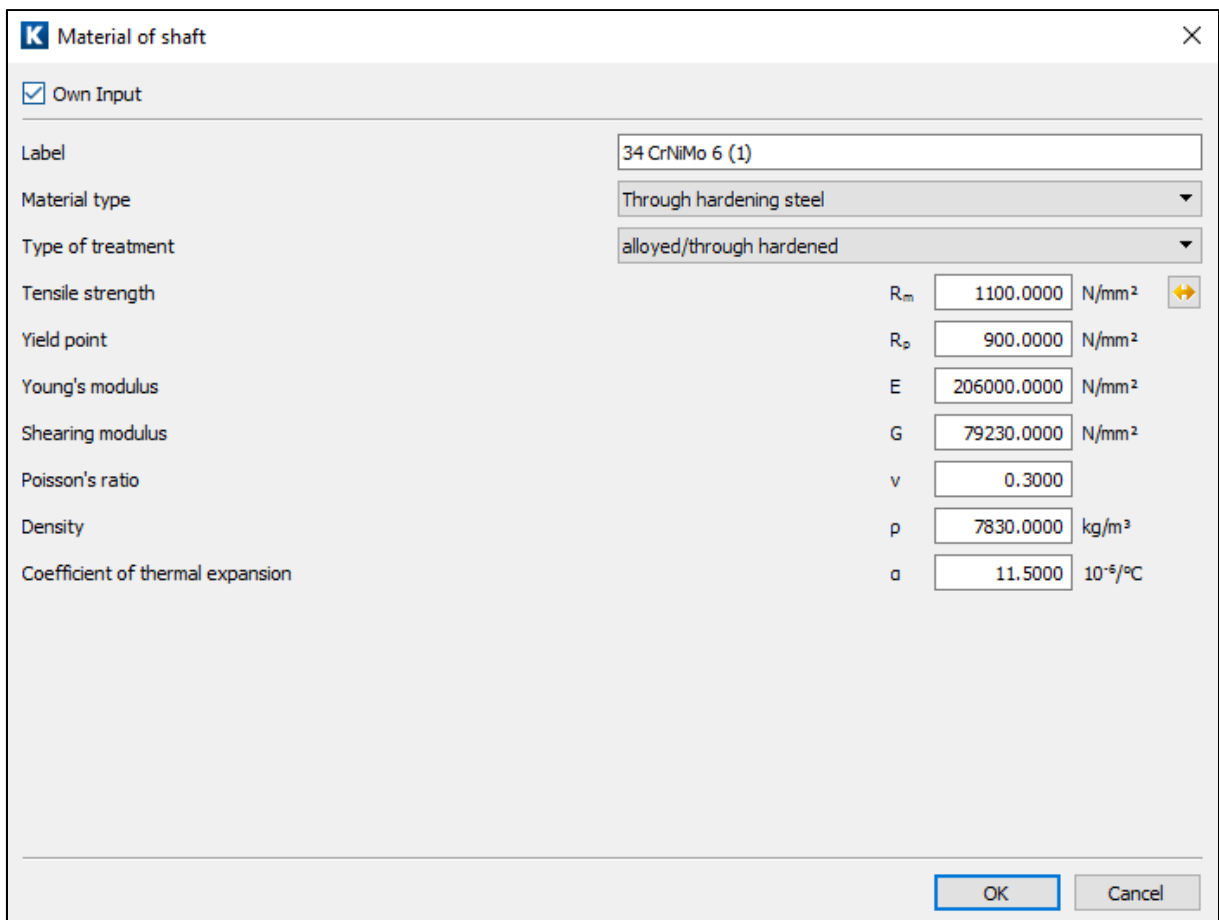

Figure 15. Defining a specific material

The data you input for this new material only applies to this calculation. After you save this file, this data is no longer available to any other calculation. However, if you want other calculations to be able to use the data for this new material, you must store this information in the material database.

#### 2.4.6 Additional loads

In the "**Radial force**" and "**Bending moment**" input fields you can also input additional radial forces and bending moments (for example, those that result from the tooth forces in a gear). The software then also calculates additional stress. To ensure no gaps occur between the hub and the shaft, the additional pressure must be less than the minimum interference pressure. If not, an error message appears and the calculation is not performed.