

KISSsoft 03/2016 – Tutorial 16

Analysing the Geometry of Cylindrical Worm Gears with Enveloping Worm Wheel

KISSsoft AG

Rosengartenstrasse 4
8608 Bubikon
Switzerland

Tel: +41 55 254 20 50
Fax: +41 55 254 20 51
info@KISSsoft.AG
www.KISSsoft.AG

Contents

1	Task	3
1.1	Task.....	3
1.2	Starting the drive element of worm gear with enveloping (globoid) worm wheel.....	3
1.3	Input data in the main screen	4
1.4	Special features of worm gear teeth flank surfaces.....	6
1.5	Input data for the gear pair	6
1.6	Inputting tolerances	8
2	Strength calculation.....	9
2.1	Results of the rating and geometry calculation.....	10

1 Task

1.1 Task

To calculate a worm gear with center distance 100 mm. The worm has 2 teeth and the worm wheel has 41 teeth. The axial/transverse module is 4. The pressure angle at the normal section is 20° . The worm's facewidth is 60 mm. You should select a sensible facewidth for the worm wheel. The axis tolerance is js7.

The worm's tooth thickness deviation in the normal section is between 0 and -0.04 mm. The tooth thickness deviation for the worm wheel is between -0.128 and -0.168. The external diameter of the worm is $44 - 0.01$ mm. The root diameter is $26.4 - 0.110$ mm. The effective tip clearance is 0.8 mm. The root radius coefficient is 0.2. The inside radius diameter is 134.4 mm.

The tolerance for the external diameter of the worm wheel is between 0 and -0.01 and for the active root diameter it is between -0.360 and -0.473. The worm is to be manufactured with accuracy grade 6 as specified in DIN 3974. The worm wheel is to be manufactured with quality 7. The lead direction is to the left. The worm's flank form is ZI.

1.2 Starting the drive element of worm gear with enveloping (globoid) worm wheel

You can call KISSsoft as soon as the software has been installed and activated. Usually you start the program by clicking "Start→Program Files→KISSsoft 03-2016→KISSsoft 03-2016". This opens the following KISSsoft user interface:

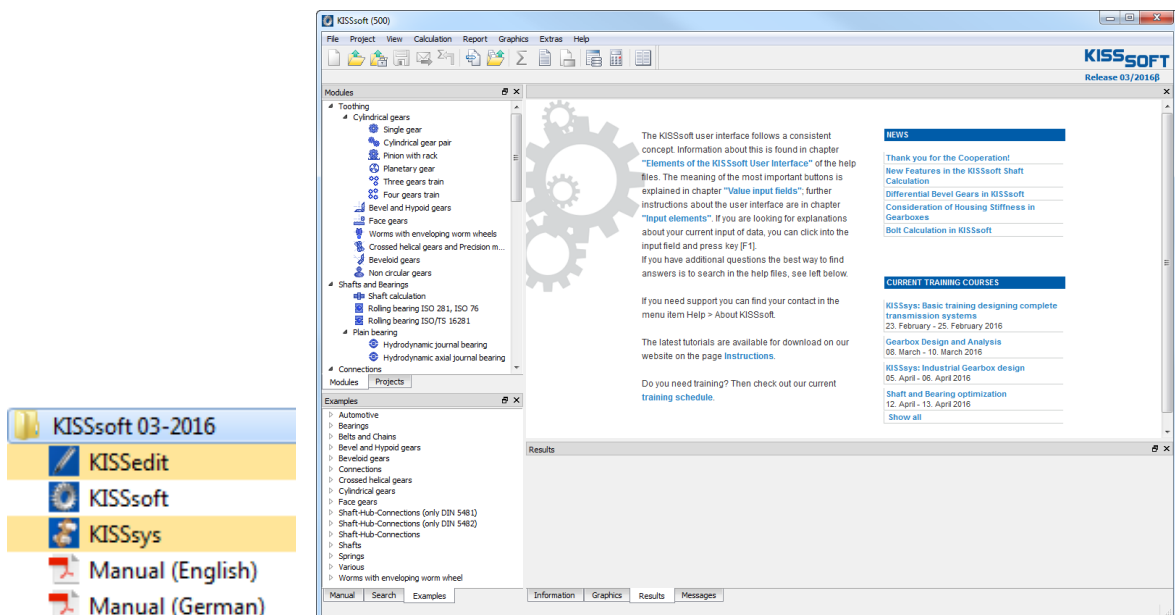

Figure 1. Starting KISSsoft, initial window

In the Modules tree window, click the "**Modules**" tab to call the "Worms with enveloping worm wheels" calculation:

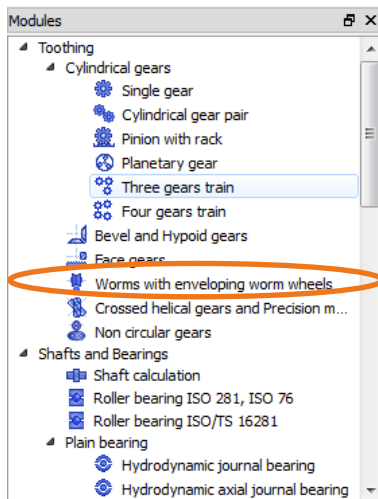

Figure 2. Call to the worm gear calculation

1.3 Input data in the main screen

After you call the 'Worms with enveloping worm wheels', the input screen appears. To only perform a geometry calculation, disable the "Calculation -> Rating" option in the menu.

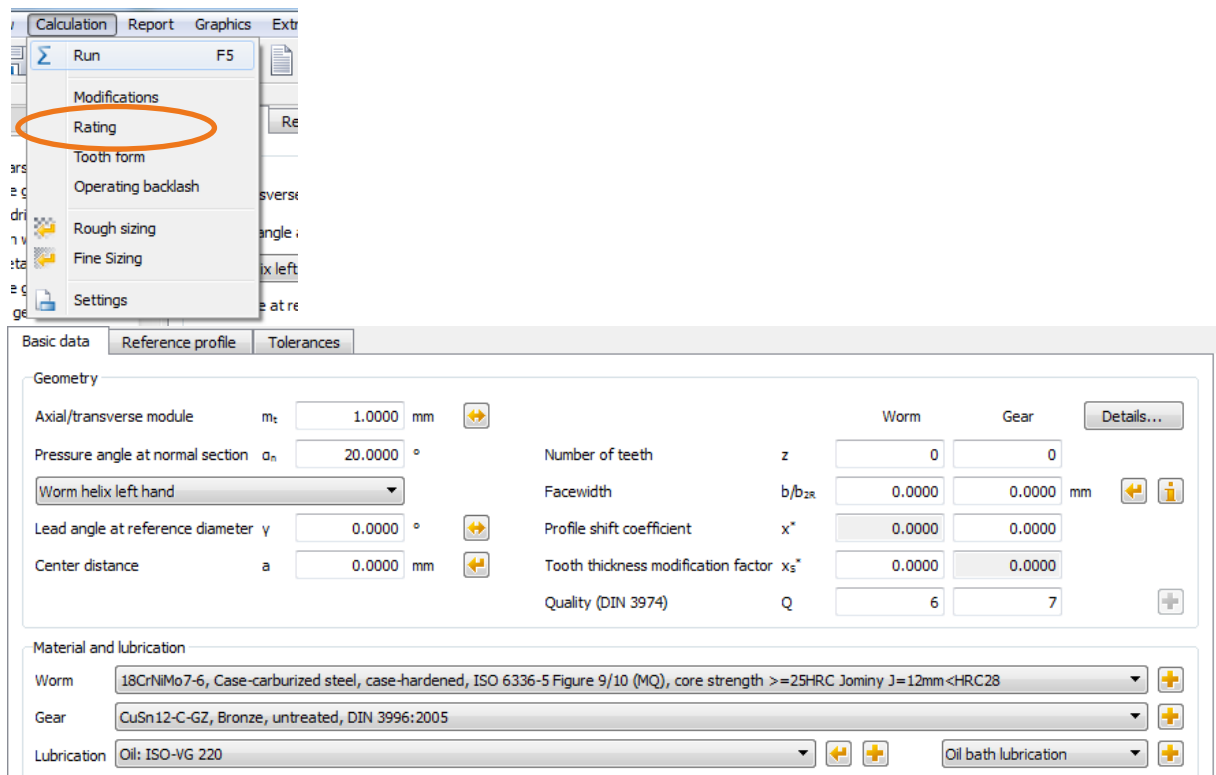

Figure 3. Input screen for worms

Input values for the axial/transverse module, number of teeth, quality, and worm face width in the **"Basic data"** tab. You must also input the center distance (1). The subsequent interim value is calculated because only the lead angle needs to be calculated. To do this, click the **"Convert button"** (2) and then click **"Calculate"** (3) to determine the lead angle. Finally, click Accept (4) to transfer this data to the main screen (see Figure 4).

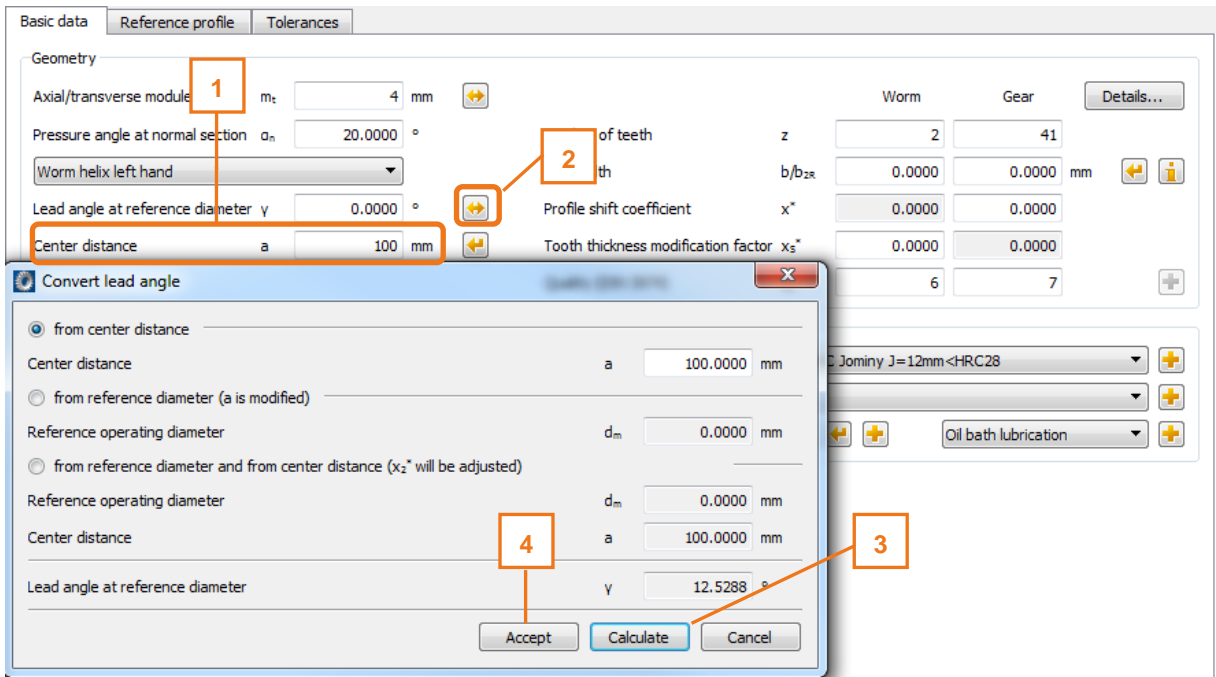

Figure 4. Interim state with the Sizing lead angle input screen

Click the **"Details"** button to call the "Define details of geometry" sub-screen and then select the appropriate flank form ZI. You must also input the inside diameter of the worm gear as 134.4 mm.

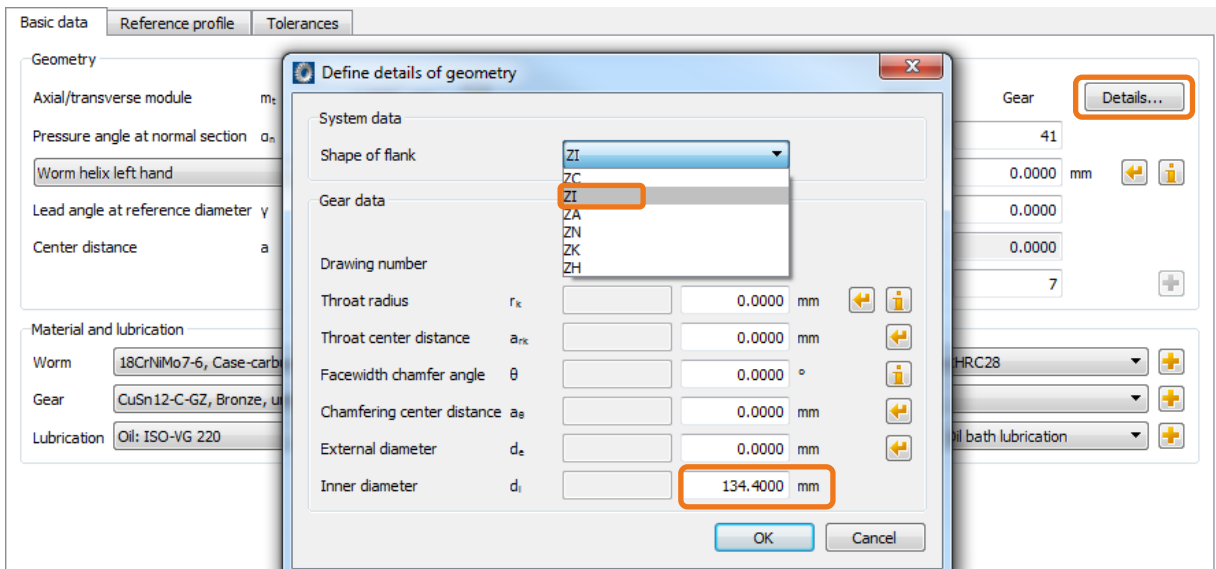

Figure 5. Interim status with "Define details of geometry" input screen

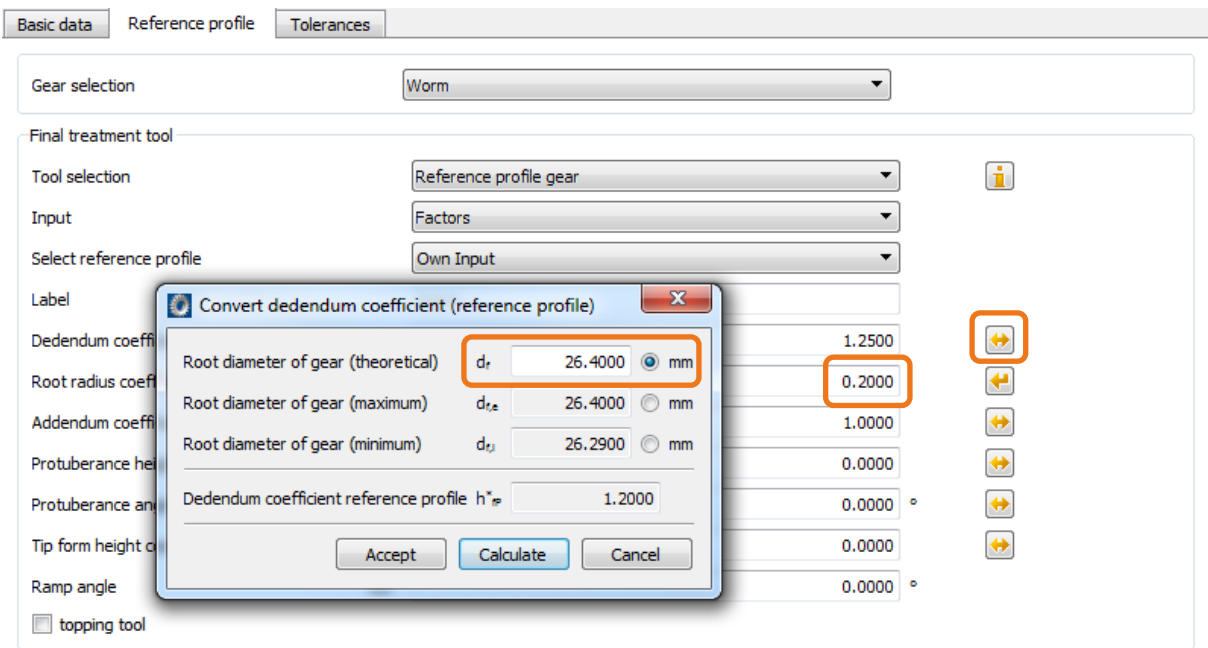



Figure 8. Calculating the worm root or tip diameter

Input 0.2 as the root radius factor. The effective tip clearance is then used to determine the root or tip diameter for the worm wheel. The root diameter is calculated from:

$$(\text{center distance} - \text{tip diameter of worm}/2 - \text{tip clearance}) \cdot 2 = (100 - 44/2 - 0.8) \cdot 2 = \underline{154.4 \text{ mm.}}$$

The tip diameter is calculated from:

$$(\text{center distance} - \text{root diameter of worm}/2 - \text{tip clearance}) \cdot 2 = (100 - 26.4/2 - 0.8) \cdot 2 = \underline{172 \text{ mm.}}$$

Once again, click the relevant "Convert"  button to convert the dedendum and addendum coefficient at the worm wheel. Then click Accept to transfer the values to the main screen.

Explanation: when you call the worm gear calculation, the system already provides predefined base settings. However, the default profile 1.25 / 0.38 / 1 ISO 53 A does not match what we want. The software already shows that it has calculated the tip diameter detailed above.

The particular geometry of globoid worm gears also means that you need to calculate the throat radius and the external diameter d_{e2} .

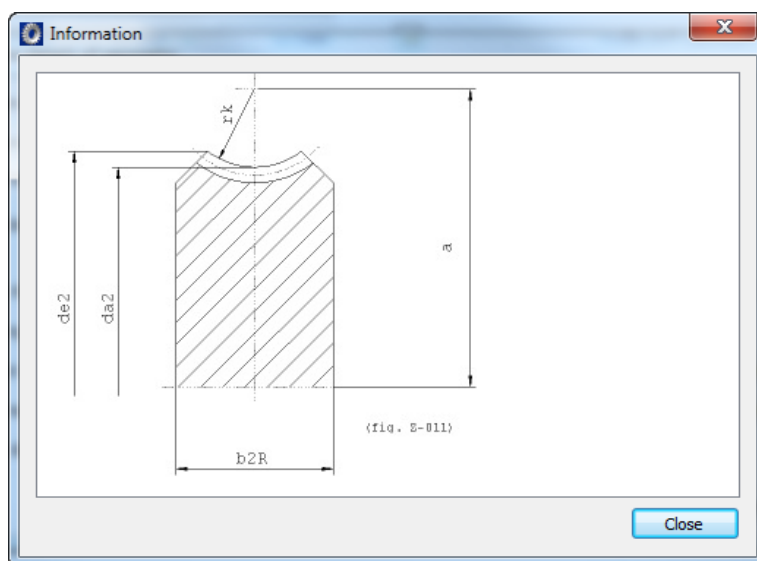

Figure 9. Geometry of globoid worm gears

In the "Basic data" tab, click the "Details" button to open the "Define details of geometry" sub-screen. Then click the Sizing button to run the required calculations for the throat radius r_k and the external diameter d_{e2} . For more information see Figure 10.

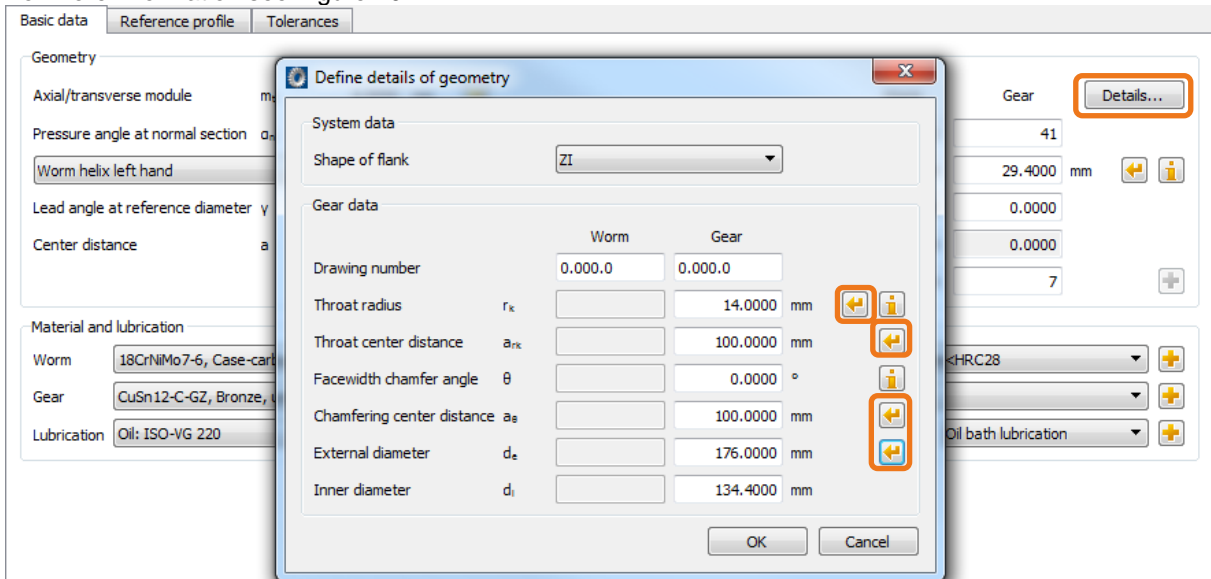

Figure 10. Calculating throat radius r_k , the external diameter d_e , throat center distance a_{rk} and chamfering center distance a_s

1.6 Inputting tolerances

In the "Tolerances" tab, select "Own Input" instead of using the predefined dimensions. Then input the tooth thickness allowance in accordance with the default values and then enter the tip diameter allowance.

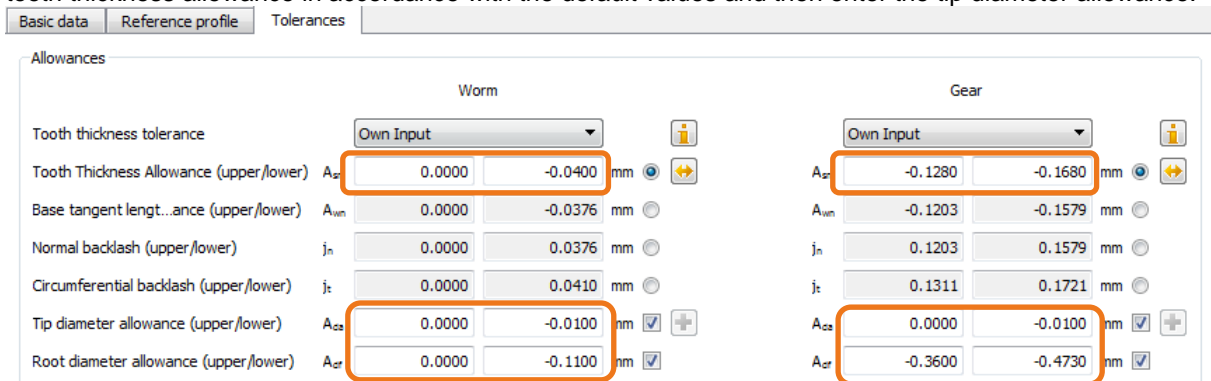

Figure 11. Inputting tooth thickness tolerance and tip diameter allowances

Then check the root diameter allowance and modify it if necessary. Now select the center distance tolerance.



Figure 12. Center distance tolerance input

The following changes must now be made so you can perform the strength calculation later on: facewidth of worm is 60 mm, increase the required facewidth of the worm wheel b_{2R} to 31 mm and the external diameter d_{e2} to 181.41 mm.

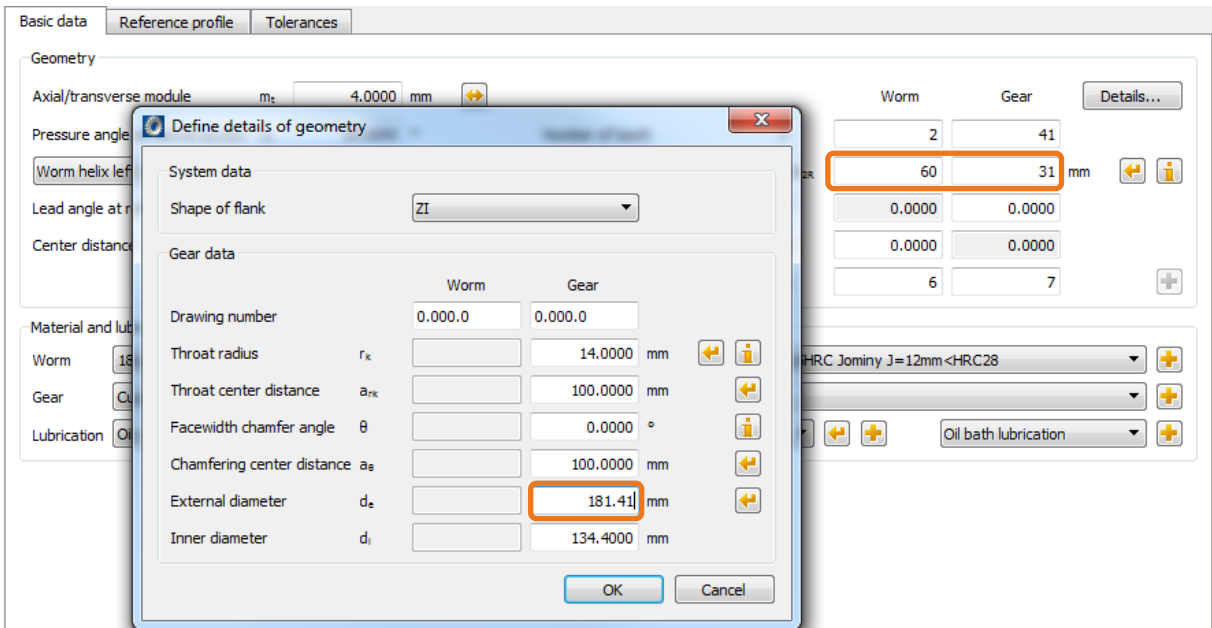

Figure 13. Final inputs

These are the results of the calculation.

2 Strength calculation

The various different calculation methods are documented in the manual (Chapter 16). Please refer to the notes if you have any questions. To open the prepared example used in this tutorial, click "File→Open" and select "WormGear 1 (DIN3996 Example 1)".

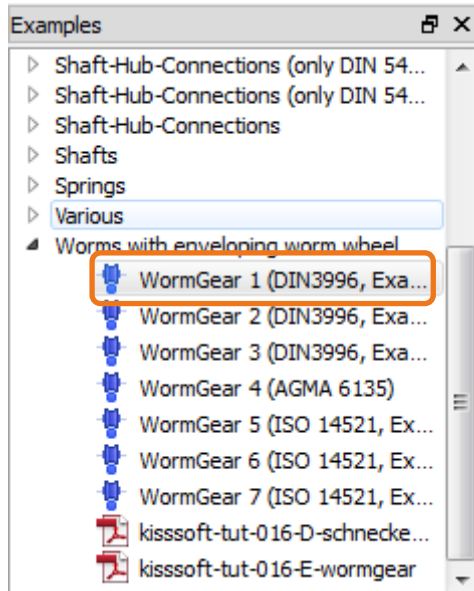

Figure 14. Opening the example calculation

2.1 Results of the rating and geometry calculation

KISSsoft Release 03/2016

KISSsoft Calculation programs for machine design

File

Name : WormGear 1 (DIN3996, Example 1)
 Description: KISSsoft example
 Changed by: on: 28.01.2016 at: 09:12:44

WORM GEAR ANALYSIS

Drawing or article number:
 Worm: 0.000.0
 Gear: 0.000.0

Calculation method DIN 3996:2012
 (Geometry: DIN 3975:2002)
 Geometry calculation from axial module

----- WORM----- WHEEL ----

Worm driving
 Working flank gear 1: Right flank

Power (kW)	[P]	5.302	4.500
Speed (1/min)	[n]	1500.0	73.2
Torque (Nm)	[T]	33.754	587.282
Application factor	[KA]		1.00
Required service life	[H]	25000.00	
Number of starts (1/h)	[Ns]		0.00

1. TOOTH GEOMETRY AND MATERIAL

Shape of flank: ZI (ISO/DTR 10828.2:2011)

----- WORM----- WHEEL ----

Center distance (mm)	[a]	100.000	
Centre distance tolerance		ISO 286:2010 Measure js7	
Shaft angle (°)	[Sigma]	90.0000	
Transverse module (mm)	[mt]		4.0000
Normal module (mm)	[mn]	3.9047	
Axial module (mm)	[mx]	4.0000	
Pressure angle at normal section (°)	[alfn]	20.0000	
Mean lead angle (°)	[gamma]	12.5288	
Hand of gear		left	left
Number of teeth	[z]	2	41
Facewidth (mm)	[b1]	60.00	
Wheel rim width b2R (mm)	[b2R]		31.00
Wheel width b2H (mm)	[b2H]		31.00
Facewidth for calculation (mm)	[b1, b2]	60.00	30.83
Accuracy grade (manufacturing)	[Vqual]	6	7
Internal diameter gearbody (mm)	[di]	0.00	134.40

Material
 Worm: 16 MnCr 5 (1), Case-carburized steel, case-hardened
 ISO 6336-5 Figure 9/10 (MQ), core strength $\geq 25\text{HRC}$ Jominy J=12mm<HRC28
 Gear 2: CuSn12Ni2-C-GZ, Bronze, untreated
 DIN 3996:2005

----- WORM----- WHEEL ----

Surface hardness		HRC 59	HBW 95
Pulsating shear strength (N/mm ²)	[rFlim]	430.00	90.00
Fatigue strength for Hertzian pressure (N/mm ²)	[σHlim]	1500.00	520.00
Material Coefficient YW	[YW]		0.95
Material lubrication coefficient	[WML_PolyG]		1.75
Tensile strength (N/mm ²)	[σB]	1000.00	300.00
Yield point (N/mm ²)	[σS]	695.00	180.00
Young's modulus (N/mm ²)	[E]	206000	98100
Poisson's ratio	[ν]	0.300	0.350
Roughness average value DS, flank (μm)	[RAH]	0.50	2.00
Roughness average value DS, root (μm)	[RAF]	0.50	2.00
Mean roughness height, Rz, flank (μm)	[RZH]	3.00	8.00
Mean roughness height, Rz, root (μm)	[RZF]	3.00	8.00

Gear reference profile	1 :		
Reference profile	1.20 / 0.20 / 1.0 DIN 867:1986		
Dedendum coefficient	[hfP*]		1.200
Root radius factor	[rhofP*]		0.200 (rhofPmax*= 0.498)
Addendum coefficient	[haP*]		1.000
Tip radius factor	[rhoaP*]		0.000
Protuberance height factor	[hprP*]		0.000
Protuberance angle	[alfprP]		0.000
Tip form height coefficient	[hFaP*]		0.000
Ramp angle	[alfKP]		0.000
		not topping	

Gear reference profile	2 :		
Reference profile	1.20 / 0.20 / 1.0 DIN 867:1986		
Dedendum coefficient	[hfP*]		1.200
Root radius factor	[rhofP*]		0.200 (rhofPmax*= 0.498)
Addendum coefficient	[haP*]		1.000
Tip radius factor	[rhoaP*]		0.000
Protuberance height factor	[hprP*]		0.000
Protuberance angle	[alfprP]		0.000
Tip form height coefficient	[hFaP*]		0.000
Ramp angle	[alfKP]		0.000
		not topping	

Summary of reference profile gears:

Dedendum reference profile	[hfP*]	1.200	1.200
Tooth root radius Refer. profile	[rofP*]	0.200	0.200
Addendum Reference profile	[haP*]	1.000	1.000
Protuberance height factor	[hprP*]	0.000	0.000
Protuberance angle (°)	[alfprP]	0.000	0.000
Tip form height coefficient	[hFaP*]	0.000	0.000
Ramp angle (°)	[alfKP]	0.000	0.000

Type of profile modification:

none (only running-in)			
Tip relief (μm)	[Ca]	0.0	0.0

Lubrication type		Oil bath lubrication
Type of oil (Own input)		Öl: ISO-VG 220
Lubricant base		Synthetic oil based on Polyglycol
Kinem. viscosity oil at 40 °C (mm ² /s)	[nu40]	220.00

Kinem. viscosity oil at 100 °C (mm ² /s)	[nu100]	37.00
Specific density at 15 °C (kg/dm ³)	[roOil]	1.020
Oil temperature (°C)	[TS]	73.226
Ambient temperature (°C)	[TU]	20.000

----- WORM----- WHEEL ----

Generating angle (°)	[alfa0]	20.000
Pressure angle at normal section (°)	[alfn]	20.000

**Indications for the manufacture of the worm wheel according to ISO 14521:
(Only valid for worm wheels which are manufactured with a hob similar to the worm.)**

Mean lead angle of the worm (°)	[gamma]	12.5288
Transverse module (mm)	[mt]	4.0000
Reference diameter (mm)	[d]	164.000
Reference operating diameter (mm)	[dm]	164.000
Throat radius (mm)	[rk]	14.000
Throat center distance (mm)	[a_rk]	100.000
Facewidth chamfer angle (mm)	[theta]	0.000
Chamfering center distance (mm)	[a_theta]	100.000
External diameter (mm)	[de]	181.410
Tip diameter (mm)	[da]	172.000
Profile shift coefficient	[x-worm]	0.0000
Pitch on reference circle (mm)	[p2]	12.566

**Indications for the manufacture of the worm wheel as a cylindrical gear
(This specification is only a suggestion. It is necessary to do a calculation of the exact geometry using the crossed-helical calculation!)**

Pressure angle at Transverse section (°)	[alfit]	(59.205)	20.448
Pressure angle at axial section (°)	[alfx]	(20.448)	59.205
Helix angle at reference circle (°)	[beta]	(77.471)	12.529
Lead angle at reference diameter (°)	[gamma]	(12.529)	77.471
Transverse module (mm)	[mt]	(18.000)	4.000
Axial module (mm)	[mx]	(4.000)	18.000
Helix angle at operating pitch circle (°)	[betas]	(77.471)	12.529
Operating pitch diameter (mm)	[dw]	(36.000)	164.000
Profile shift coefficient	[x-DIN3960]	(0.0000)	0.0000

Overall transmission ratio	[itot]	-20.500	
Gear ratio	[u]	20.500	
Base helix angle (°)	[betab]		11.762
Reference centre distance (mm)	[ad]	100.000	
Diametral factor q	[q]	9.000	
Sum of profile shift coefficients	[Summexi]	0.0000	
Profile shift coefficient	[x-worm]	0.0000	0.0000
Profile shift (x*m) (mm)	[x*mx]	0.0000	0.0000

(The profile shift is related to the axial module of the worm subject to ISO TR 14521:2010/DIN 3975:2002.)

Tip alteration (mm)	[k*mn]	0.000	0.000
Theoretical tip clearance (mm)	[c]	0.800	0.800
Effective tip clearance (mm)	[c.e/i]	1.059/ 0.963	0.877/ 0.782
Reference operating diameter (mm)	[dm]	36.000	164.000
Reference diameter (mm)	[d]		164.000
Base diameter (mm)	[db]		153.666
Tip diameter (mm)	[da]	44.000	172.000
Tip form diameter (mm)	[dFa]	44.000	172.000
(mm)	[dFa.e/i]	44.000/ 43.990	172.000/ 171.990
Tip diameter allowances (mm)	[Ada.e/i]	0.000/ -0.010	0.000/ -0.010

Root diameter (mm)	[df]	26.400	154.400
Generating Profile shift coefficient	[xE.e/i]		-0.0450/ -0.0591
Manufactured root diameter with xE (mm)	[df.e/i]	26.400/26.290	154.040/153.927
Lead height (mm)	[pz]	25.133	
Axial pitch (mm)	[px]	12.566	
Transverse contact ratio (approximate value following Thomas-Charchut)	[eps_a]	1.911	
For ZI-worms:			
Base diameter (mm)	[db]	18.431	
Base lead angle (°)	[gamb]	23.463	
Base pitch (mm)	[pb]	11.527	

2. FACTORS OF GENERAL INFLUENCE

		----- WORM-----	WHEEL ----
Nominal circum. force at pitch circle (N)	[Ft]	1875.2	7162.0
Axial force (N)	[Fa]	-7162.0	-1875.2
Radial force (N)	[Fr]	2847.3	-2847.3
Normal force (N)	[Fn]	8343.7	
Circumferential speed reference circle (m/s)	[v]	2.827	0.628
Sliding velocity an mean circle (m/s)	[vgm]	2.896	
Number of load cycles (in mio.)	[NL]	2249.999	109.756
Data of reference gearbox:			
Equivalent Young's modulus (N/mm ²)	[EredT]	150622.00	
Surface roughness of worm (µm)	[RaT]	0.500	
Center distance (mm)	[aT]	100.000	
Transmission ratio	[uT]	20.500	
Reference operating diameter (mm)	[dm1T]	36.000	164.000
Characteristic value for mean Hertzian pressure	[pmT*]	0.962	
Characteristic value for mean lubricant gap thickness	[hT*]	0.070	
Characteristic value for mean sliding path	[sT*]	30.800	
Physical characteristic values:			
Characteristic value for mean lubrication Space width	[h*]	0.0692	
Characteristic value for mean Hertzian pressure	[pm*]	0.9470	
Characteristic value for mean sliding path	[s*]	30.2850	
Efficiency according method C:			
Rolling bearing with set support			
Bearing loss-power (kW)	[PVLp]	0.126	
Number of sealings (worm-shaft)	[nVD]	2	
Sealing loss power (kW)	[PVD]	0.046	
Idle loss power (kW)	[PV0]	0.153	
Base friction number	[muOT]	0.0245	
Size factor	[YS]	1.000	
Geometry factor	[YG]	1.006	
Roughness factor	[YR]	1.000	
Material Coefficient YW	[YW]	0.950	
Mean tooth friction number	[muzm]	0.0234	
Tooth friction angle (°)	[roz]	1.341	
Meshing efficiency (%)	[etaz]	90.002	
Mesh loss power (kW)	[PVZ]	0.477	
Total loss power (kW)	[PV]	0.802	
Total efficiency (%)	[etaGes]	84.872	

Wheel bulk temperature:		
Lubrication type		Oil bath lubrication
Worm submerges into lubricant		
Cooling area of wheel-pair (cm ²)	[AR]	50.840
Heat-transfer coefficient wheels (W/m ² /K)	[alfL]	24439.990
Wheel bulk temperature (°C)	[theM]	77.1
Oil sump temperature (°C)	[theS]	73.2

3. WEAR SUPPORT CAPABILITY ACCORDING METHOD B.C

Mean lubricant gap thickness (µm)		[hminm]	0.2480
(hminm calculated with etaOM=	0.0642 Ns/m ²	theM=77.1°)	
Pressure factor		[WH]	1.0000
Factor for lubricant structure		[WS]	2.6140
Factor for start		[WNS]	1.0000
Characteristic value		[Kw]	0.6484
Wear intensity		[JOT]	5.10181e-010
Wear intensity		[Jw]	8.92817e-010
Wear path (m)		[sWm]	815829
Wear removal (mm)		[delWn]	0.728
Permissible tooth thickness reduction (coefficient in module)		[DeltaS]	0.300
Permissible mass decrease (kg)			
Normal tooth thickness at tip circle (mm)		[san]	2.907
(mm)		[san.e/i]	2.778/ 2.731
Permissible wear on flank (mm)		[delWlimn]	1.171
Limited by: Permissible tooth thickness decrease			
Safety against wear		[SW]	1.608
Required safety		[SWmin]	1.100
As information:			
Achievable service life (with SW =	1.100) (h)	[Lh]	36551.07

4.PITTING SUPPORT CAPABILITY ACCORDING METHOD B.C

			----- WORM----- WHEEL ----
Equivalent Young's modulus (N/mm ²)		[Ered]	149673.38
Mean flank pressure (N/mm ²)		[sigHm]	367.36
Life coefficient		[Zh]	1.000
Speed factor		[ZV]	0.851
Size factor		[ZS]	1.000
Lubrication factor		[Zoil]	1.000
Ratio factor		[Zu]	1.000
Boundary value of average flank pressure (N/mm ²)		[sigHG]	442.766
Safety for surface pressure on flank		[SH]	1.205
Required safety		[SHmin]	1.000
As information:			
Achievable service life (with SHmin =	1.000) (h)	[Lh]	76640.67

5. BENDING SAFETY

Bearing distance l1 (mm)		[l1]	150.000
Distance l11 (mm)		[l11]	75.000
Deflection (mm)		[delm]	0.030
Boundary value bending (mm)		[dellim]	0.080

Safety for bending	[Sdel]	2.632
Required safety	[Sdelmin]	1.000

6. TOOTH ROOT SUPPORT CAPABILITY ACCORDING METHOD C

----- WORM----- WHEEL ----

Calculation taking into account the decrease of the tooth thickness due to wear

(with minimum (delWn, delWlimn))

Tooth thickness at root (mm)	[sft2]	9.663
Tooth form factor	[YF2]	1.200
Contact ratio factor	[Yeps]	0.500
Lead coefficient	[Ygam]	1.024
Rim thickness (mm)	[sk2]	10.000
Rim thickness coefficient	[YK2]	1.000
Nominal shear stress at tooth root (N/mm ²)	[tauF2]	35.51
No Quality reduction by small plastic deformation is accepted.		
Life coefficient	[YNL]	1.000
Boundary value of shear stress at tooth root (N/mm ²)	[tauFG]	90.00
Safety for Tooth root stress	[SF]	2.534
Required safety	[SFmin]	1.100

7. TEMPERATURE SAFETY ACCORDING METHOD C

Housing with cooler

Ambient temperature (°C)	[TU]	20.0
Oil temperature (°C)	[theOil]	73.2
Boundary value oil temperature (°C)	[theSlim]	100.0
Temperature safety	[ST=theSlim/theOil]	1.366
Required safety	[STmin]	1.100
Oil sump temperature (°C)	[theS]	73.2
(Safety	[theSlim/theS]	1.366)

8. ALLOWANCES FOR TOOTH THICKNESS

Tooth thickness deviation

Worm:	Own Input
Gear:	Own Input

----- WORM----- WHEEL ----

Tooth thickness allowance (normal section) (mm)	[As.e/i]	0.000/ -0.040	-0.128/ -0.168
Backlash free center distance (mm)	[aControl]	99.820/ 99.707	
Backlash free center distance, allowances (mm)	[jta]	-0.180/ -0.293	
Number of teeth spanned	[k]	5.000	
Base tangent length (mm)	[Wk]	54.275	
Actual base tangent length ('span') (mm)	[Wk.e/i]	54.155/ 54.117	
Diameter of contact point (mm)	[dMWk.m]	162.549	
Base tangent length (span): Can only be measured, if the worm-wheel is manufactured like a cylindrical gear!			
Theoretical diameter of ball/pin (mm)	[dm]	6.545	6.615
Eff. Diameter of ball/pin (mm)	[DMeff]	7.000	7.000
Radial one ball mass (mm)	[MrK]		87.190
Actual dimension centre to ball (mm)	[MrK.e/i]		87.034/ 86.985
Diameter of contact point (mm)	[dMMr.m]	37.166	164.455

Diametral two ball measure (mm)	[MdK]		174.257
Actual dimension over balls (mm)	[MdK.e/i]		173.946/173.848
Theoretical dim. over 3 wires (mm)	[Md3R]	46.559	
Actual diametral dimensions over 3 rolls (mm)	[Md3R.e/i]	46.559/46.452	
Normal tooth thickness (chord) in the reference circle (mm)	[sc]	6.133	6.132
	(mm) [sc.e/i]	6.133/ 6.093	6.004/ 5.964
Tooth thickness in the transverse section (chord) in the reference circle (mm)	[st]		6.282
	(mm) [st.e/i]		6.151/ 6.110
Tooth thickness in the transverse section (Arc) (mm)	[st]		6.283
	(mm) [st.e/i]		6.152/ 6.111
Tooth thickness on axial cut (mm)	[smx]	6.283	
	(mm) [smx.e/i]	6.283/ 6.242	
Tooth space in axial cut (mm)	[emx]	6.283	
	(mm) [emx.e/i]	6.283/ 6.324	
Reference chordal height from da.m (mm)	[ham1, ha2]	3.997	4.052
Centre distance allowances (mm)	[Aa.e/i]	0.018/ -0.018	
Circumferential backlash (transverse section) (mm)	[jt]	0.226/ 0.118	
Normal backlash (mm)	[jn]	0.207/ 0.108	

9. GEAR ACCURACY

----- WORM----- WHEEL ----

According to DIN 3974:1995:

Accuracy grade	[Vqual]	6	7
Single pitch deviation (μm)	[fpx, fp2]	8.50	13.00
Adjacent pitch difference (μm)	[fux, fu2]	11.00	16.00
Total deviation of the slope (μm)	[Fpz]	11.00	
Total cumulative pitch deviation (μm)	[Fp2]		51.00
Profile slope deviation (μm)	[fHa]	7.50	11.00
Profile form deviation (μm)	[ffa]	11.00	15.00
Total profile deviation (μm)	[Fa]	13.00	19.00
Runout (μm)	[Fr]	18.00	35.00
Single flank composite, total (μm)	[Fi']	29.00	56.00
Single flank composite, tooth-to-tooth (μm)	[fi']	15.00	22.00

10. ADDITIONAL DATA

Weight - calculated with da (kg)	[Mass]	0.714	2.455
Start under load:			
Tooth friction number (acc. Niemann)	[muzm_S]	0.140	
Torque (Nm)	[T1_S]	48.195	587.282

11. SERVICE LIFE, DAMAGE

Required safety for tooth root	[SFmin]	1.10
Required safety for tooth flank	[SHmin]	1.00
Service life (calculated with required safeties):		
System service life (h)	[Hatt]	36551

Tooth root service life (h)	[HFatt]	1e+006	1e+006
Tooth flank service life (h)	[HHatt]	1e+006	1e+006

Note: The entry 1e+006 h means that the Service life > 1,000,000 h.

Damage calculated on the basis of the required service life

[H] (25000.0 h)

F1%	F2%	H1%	H2%
0.00	0.00	0.00	0.00

Damage calculated on basis of system service life

[Hatt] (36551.1 h)

F1%	F2%	H1%	H2%
0.00	0.00	0.00	0.00

REMARKS:

- Specifications with [e/i] imply: Maximum [e] and Minimal value [i] with consideration of all tolerances
- The specification of circumferential backlash (as well as the backlash-free distance for the tooth thickness check) is not yet fully checked, and serves only as a guide.
- The details of the chordal tooth thickness are imprecise and merely an indication (The calculation is done according to ISO TR 14521:2010/DIN 3975:2002, without taking into account the exact shape of flank.).
- In ISO14521 and DIN3996, the necessary data for each material are not always complete. In such a case you get the message: "Not calculated (material data missing)"

End of Report

lines: 424
